



SMART Board®

6000S | 6000S Pro

series interactive displays

Installation and maintenance guide

SBID-6265S-V3 | SBID-6275S-V3 | SBID-6286S-V3 | SBID-6265S-V3-PW | SBID-6275S-V3-PW | SBID-6286S-V3-PW
SBID-6265S-V3-P | SBID-6275S-V3-P | SBID-6286S-V3-P
SBID-6065S-V3 | SBID-6075S-V3 | SBID-6086S-V3 | SBID-6065S-V3-PW | SBID-6075S-V3-PW | SBID-6086S-V3-PW
SBID-6065S-V3-P | SBID-6075S-V3-P | SBID-6086S-V3-P
SBID-6465S-V3-P | SBID-6475S-V3-P | SBID-6486S-V3-P
SBID-6265S-C | SBID-6275S-C | SBID-6286S-C | SBID-6265S-CPW | SBID-6275S-CPW | SBID-6286S-CPW
SBID-6065S-C | SBID-6075S-C | SBID-6086S-C | SBID-6065S-CPW | SBID-6075S-CPW | SBID-6086S-CPW
SBID-6265S | SBID-6275S | SBID-6286S | SBID-6265S-PW | SBID-6275S-PW | SBID-6286S-PW
SBID-6065S | SBID-6075S | SBID-6086S | SBID-6065S-PW | SBID-6075S-PW | SBID-6086S-PW
IDS665-3 | IDS675-3 | IDS686-3
IDS665-1 | IDS675-1 | IDS686-1



Was this document helpful?
smarttech.com/docfeedback/171414





Learn more

This guide and other resources for SMART Board 6000S and 6000S Pro series interactive displays are available in the Support section of the SMART website (smarttech.com/support). Scan this QR code to view these resources on your mobile device.



ENERGY STAR® is the government-backed symbol for energy efficiency, providing simple, credible, and unbiased information that consumers and businesses rely on to make well-informed decisions. ENERGY STAR-certified products are the simple choice for energy efficiency, making it easy for consumers and businesses to make purchases that save them money and protect the environment. The U.S. EPA ensures that each product that earns the label is independently certified to deliver the quality, performance, and savings that users have come to expect.

As shipped, your display delivers ENERGY STAR performance and savings. However, changing some settings may increase energy consumption beyond the limits required for ENERGY STAR certification. For example, increased brightness and contrast will increase power consumption.

Please consider the environment when you choose non-ENERGY STAR settings.

Licenses



The terms HDMI, HDMI High-Definition Multimedia Interface, HDMI trade dress and the HDMI Logos are trademarks or registered trademarks of HDMI Licensing Administrator, Inc.

The Bluetooth word mark is owned by the Bluetooth SIG, Inc. and any use of such marks by SMART Technologies ULC is under license.

Trademark notice

SMART Board, SMART Notebook, SMART TeamWorks, SMART Meeting Pro, Pen ID, HyPr Touch, Object Awareness, Silktouch, Tool Explorer, smarttech, the SMART logo and all SMART taglines are trademarks or registered trademarks of SMART Technologies ULC in the U.S. and/or other countries. The Bluetooth word mark is owned by the Bluetooth SIG, Inc. and any use of such marks by SMART Technologies ULC is under license. The Adopted Trademarks HDMI, HDMI High-Definition Multimedia Interface, and the HDMI Logo are trademarks or registered trademarks of HDMI Licensing Administrator, Inc. in the United States and other countries. All other third-party product and company names may be trademarks of their respective owners.

Copyright notice

© 2022 SMART Technologies ULC. All rights reserved. No part of this publication may be reproduced, transmitted, transcribed, stored in a retrieval system or translated into any language in any form by any means without the prior written consent of SMART Technologies ULC. Information in this manual is subject to change without notice and does not represent a commitment on the part of SMART.

This product and/or use thereof is covered by one or more of the following U.S. patents:

www.smarttech.com/patents

July 29, 2022

Important information

Warning

- Failure to follow the installation instructions included with the display could result in injury and product damage which may not be covered by the warranty.
- Do not open or disassemble the display. You risk electrical shock from the high voltage inside the casing. Opening the casing also voids the warranty.
- Do not stand (or allow children to stand) on a chair to touch the surface of the display. Rather, mount the product at the appropriate height.
- To reduce the risk of fire or electric shock, do not expose the display to rain or moisture.
- If the display requires replacement parts, make sure the service technician uses replacement parts specified by SMART Technologies or parts with the same characteristics as the original.
- Ensure that any cables that cross the floor to the display are properly bundled and marked to avoid a trip hazard.
- Do not insert objects inside the cabinet ventilation holes, because they could touch dangerous voltage points and cause electric shock, fire or product damage which may not be covered by the warranty.
- Do not place heavy objects on the power cable. Damage to the cable could cause shock, fire, or product damage which may not be covered by the warranty.
- Use only extension cords and outlets that can fully accommodate the display's polarized plug.
- Use the power cable provided with the display. If a power cable is not supplied, contact your supplier. Use only power cables that match the AC voltage of the power outlet and that comply with your country's safety standards.
- If the glass is broken, do not touch the liquid crystal. To prevent injury, handle glass fragments with care when disposing of them.
- Do not move or mount the display by connecting rope or wire to its handles. The display is heavy, and failure of the rope, wire, or handle could lead to injury.
- Use only VESA-approved mounts.

- Disconnect the display's power cable from the wall outlet and seek assistance from qualified service personnel if any of the following occur:
 - The power cable or plug is damaged
 - Liquid is spilled into the display
 - Objects fall into the display
 - The display is dropped
 - Structural damage, such as cracking, occurs
 - The display behaves unexpectedly when you follow operating instructions

 **Caution**

- Turn off the display before cleaning its screen. Otherwise, you may scramble the desktop icons or inadvertently activate applications when you wipe the screen.
- Avoid setting up and using the display in an area with excessive levels of dust, humidity, and smoke.
- Make sure an electrical socket is near the display and remains easily accessible during use.
- In Europe, the display should be used only with European TN and TT power distribution systems.

It is not suitable for older, IT-type power distribution systems found in some European countries. "This system (IT-type) is widely used isolated from earth, in some installations in France, with impedance to earth, at 230/400V, and in Norway, with voltage limiter, neutral not distributed, at 230V line-to-line."

Contact qualified personnel if you're uncertain of the type of power system available where you're installing the display.

- The accessory slot's maximum available power is 60 W. The slot is not a limited power source. To reduce the risk of fire, make sure that accessories connecting to the slot satisfy the fire enclosure requirements of IEC 60950-1 and IEC 62368-1.
- You must connect the USB cable that came with the display to a computer that has a USB compliant interface and that bears the USB logo. In addition, the USB source computer must be compliant with IEC 60950-1 and/or IEC 62368-1. It must be certified by UL or CSA or another NRTL / SCC certified body to CSA/UL 60950-1 or CSA/UL 62368-1 and it must have the CE marking. This is for operating safety and to avoid damage to the display.
- Wait five minutes before removing accessories from the display's OPS slot to allow the accessory to cool.

! Important

- The following table shows the typical operating power for the display:

Models	Regulatory Models	Typical power
6000S (V3)		
SBID-6X65S-V3, SBID-6X65S-V3-PW, SBID-6X65S-V3-P,	IDS665-3	100V to 240V AC, 50 Hz to 60 Hz, 105 W
SBID-6X75S-V3, SBID-6X75S-V3-PW, SBID-6X75S-V3-P,	IDS675-3	100V to 240V AC, 50 Hz to 60 Hz, 134 W
SBID-6X86S-V3, SBID-6X86S-V3-PW, SBID-6X86S-V3-P,	IDS686-3	100V to 240V AC, 50 Hz to 60 Hz, 161 W
6000S (C) and SBID-6000S		
SBID-6X65S-C, SBID-6X65S-CPW SBID-6X65S, SBID-6X65S-PW, SBID-6X65-P	IDS665-1	100V to 240V AC, 50 Hz to 60 Hz, 92W
SBID-6X75S-C, SBID-6X75S-CPW SBID-6X75S, SBID-6X75S-PW, SBID-6075-P	IDS675-1	100V to 240V AC, 50 Hz to 60 Hz, 141W
SBID-6X86S-C, SBID-6X86S-CPW SBID-6X85S, SBID-6X85S-PW, SBID-6X86-P	IDS686-1	100V to 240V AC, 50 Hz to 60 Hz, 172W

- For additional requirements and other information, refer to the display's specifications (see *More information* on page 19).

Contents

Important information	3
Chapter 1 Welcome	8
About this guide	9
About the display	9
Identifying your specific model	16
Accessories	18
More information	19
Chapter 2 Installing the display	20
Moving the display to the installation site	20
Installing the display on a wall	22
Installing the display on a stand	27
Connecting to a network	28
Connecting power and turning on the display for the first time	29
About energy saving modes	30
Chapter 3 Connecting computers and other devices	31
Installing SMART software	31
Connecting room computers and guest laptops	33
Connecting a SMART OPS PC module	36
Connecting other devices	36
Connector diagrams	40
Chapter 4 Maintaining the display	45
Turning off, turning on, and resetting the display	45
Cleaning and maintaining hardware	46
Updating system software	50
Chapter 5 Troubleshooting	51
The display isn't turning on	51
The display is turning on when it shouldn't	52
The screen is blank or there's a problem with the image on the screen	52
There's no sound or there's a problem with the sound	54
Touch isn't working as expected	55
The pens and erasers aren't working as expected	56
iQ apps aren't working as expected	57
The remote control isn't working as expected	57
SMART software on connected computers isn't working as expected	57

The SMART OPS PC module isn't working as expected	57
Contacting your reseller for additional support	58
Appendix A Adjusting settings	59
Network settings	59
Personalization	60
Application settings	61
System settings	64
Appendix B Enrolling the display in SMART Remote Management	73
Appendix C Managing the SMART Board 6000S (V3) display using RS-232	74
Configuring the computer's serial interface settings	75
Commands and responses	76
Power state commands	77
Input commands	79
Brightness commands	79
Freeze commands	79
Screen shade commands	80
Volume commands	80
Mute commands	80
Firmware version commands	80
Serial number commands	81
Part number commands	81
Model number commands	81
Resolving issues with managing the display using RS-232	81
Appendix D Managing SMART Board 6000S (C) or 6000S series displays using RS-232	82
Connecting multiple displays	83
Configuring the computer's serial interface settings	84
Commands and responses	84
Power state commands	87
Input commands	89
Brightness commands	89
Freeze commands	90
Screen shade commands	90
Volume commands	90
Mute commands	90
Firmware version commands	91
Serial number commands	91
Part number commands	91
Resolving issues with managing the display using RS-232	92
Certification and compliance	93

Chapter 1 **Welcome**

- About this guide 9
- About the display 9
 - Touch10
 - Writing, drawing and erasing10
 - Support for additional pens and tools 11
 - iQ experience 11
 - Display 11
 - Audio 12
 - Network connectivity 12
 - Room computers and guest laptops 12
 - Accessory slot 13
 - Convenience panel 13
 - Proximity sensor13
 - Ambient light sensor 14
 - Remote control and IR sensor14
 - Temperature and humidity sensors 15
 - Microphone array15
 - NFC sign in 15
 - Mounting hardware 15
 - Accessory mounting points16
- Identifying your specific model 16
- Accessories18
 - Pen accessory kit18
 - Tool Explorer-enabled objects and manipulatives 18
 - SMART OPS PC module19
 - Stands19
 - USB extenders 19
- More information 19

This chapter introduces the SMART Board® 6000S and 6000S Pro series interactive displays.

About this guide

This guide explains how to install and maintain a SMART Board 6000S or 6000S Pro series interactive display. It includes the following information:

- How to install the display
- How to connect power and devices
- How to turn on the display for the first time and configure the iQ experience
- How to maintain the display for years of use
- How to troubleshoot issues with the display

This guide also includes information about the display's settings and remote management support.

This guide is intended for those who install and maintain displays in their organizations. Additional documentation and resources are available for users of the display (see *More information* on page 19).

About the display

The SMART Board 6000S or 6000S Pro series interactive display with iQ is the hub of your classroom or meeting room.

Note

The following features are available on the SMART Board 6000S (V3) models. SMART Board 6000S and 6000S (C) models don't include a microphone array, and the sensors are located in the top-left corner of the display's frame.

The display includes an extensive set of features and components:



Touch

You can do everything on the display that you can do at your computer—open and close applications, meet with others, create new documents or edit existing ones, visit websites, play and manipulate videos, and so on—by touching the display’s surface.

You can use an array of gestures within applications, including panning, scaling, rotating and zooming in and out.

The display’s advanced HyPr Touch™ (Hybrid Precision Touch) with InGlass™ touch technology provides a natural, intuitive writing and touch experience with high accuracy and low latency. In addition, its Silktouch ultra-smooth finish allows you to use the display for hours without finger burn.

Writing, drawing and erasing



The display comes with a black pen and a red pen that you can use to write or draw on the screen.

The display also includes two erasers, which you can use to erase digital ink.

With Object Awareness, the display responds automatically to the tool or object you’re using, whether it’s a pen, finger, eraser, or palm. The display’s Pen ID and Simultaneous Tool Differentiation technologies allow multiple people to write independently and simultaneously, using different colored ink.

Support for additional pens and tools

The SMART Board 6000S features the Tool Explorer™ platform, which enables you to use other SMART-authorized pens and tools in addition to those supplied with the display. The Tool Explorer platform lets teachers and students manipulate real-world objects to interact intuitively with on-screen objects and digital content, increasing engagement and knowledge retention.

For more information about using Tool Explorer-enabled objects on the display, see the *SMART Board 6000S and 6000S Pro series interactive displays user guide* (smarttech.com/kb/171415).

For more information about available tool kits, see smarttech.com/kb/171796.

iQ experience

If enabled, the display's iQ experience provides one-touch access to collaborative tools, such as a whiteboard, wireless screen sharing, and a web browser. There's no need for wires, cables, or manual software and firmware updates.

Note

Some features, such as Browser and Screen Share, require a properly configured network connection.

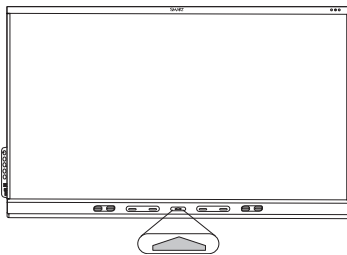

Press the **Home** button on the display (pictured) or the remote control to open the Home screen. From the Home screen, you can open the iQ apps, switch inputs, and adjust settings.

Display

The 4K ultra-high-definition LED display provides optimal image clarity and wide viewing angles.

The size of the display varies by model:

Models	Size (diagonal)
SBID-6265S-V3, SBID-6265S-V3-PW, SBID-6265S-V3-P, SBID-6065S-V3, SBID-6065S-V3-PW, SBID-6065S-V3-P, SBID-6465-V3-P	65"
SBID-6265S-C, SBID-6265S-CPW, SBID-6065S-C, SBID-6065S-CPW	
SBID-6265S, SBID-6265S-PW, SBID-6065S, SBID-6065S-PW, SBID-6065S-P	

Models	Size (diagonal)
SBID-6275S-V3, SBID-6275S-V3-PW, SBID-6275S-V3-P, SBID-6075S-V3, SBID-6075S-V3-PW, SBID-6075S-V3-P, SBID-6475-V3-P SBID-6275S-C, SBID-6275S-CPW, SBID-6075S-C, SBID-6075S-CPW SBID-6275S, SBID-6275S-PW, SBID-6075S, SBID-6075S-PW, SBID-6075S-P	75"
SBID-6286S-V3, SBID-6286S-V3-PW, SBID-6286S-V3-P, SBID-6086S-V3, SBID-6086S-V3-PW, SBID-6086S-V3-P, SBID-6486-V3-P SBID-6286S-C, SBID-6286S-CPW, SBID-6086S-C, SBID-6086S-CPW SBID-6286S, SBID-6286S-PW, SBID-6086S, SBID-6086S-PW, SBID-6086S-P	86"

Audio

The display includes two 20 W integrated speakers, which are designed to provide sound at the front of a room.

Tip

You might want to connect an external audio system if you're providing sound in a larger space (see *Connecting an external audio system* on page 38).

Network connectivity

The display requires a network connection for downloading software and firmware updates, and a number of the iQ apps require a network connection as well.

You can connect to a network using Wi-Fi or an Ethernet cable:

- The Wi-Fi module supports both 2.4 and 5 GHz bands.
- The two RJ45 jacks allow you to connect the display and an external device, such as a computer, to a Gigabit Ethernet network.

For more information, see *Connecting to a network* on page 28.

Room computers and guest laptops

You can connect room computers and guest laptops to the display and view and interact with their inputs.

The display comes with SMART software that you can install on connected computers to take full advantage of the display's features while using the connected computers.

For more information, see *Connecting room computers and guest laptops* on page 33.

Accessory slot

You can install an OPS-compatible device, such as a SMART OPS PC module, in the accessory slot. SMART OPS PC modules provide a complete Windows® 10 Pro installation.

For more information on SMART OPS PC modules, see *SMART OPS PC module* on page 19.

Caution.

- The accessory slot's maximum available power is 60 W. The slot is not a limited power source. To reduce the risk of fire, make sure that accessories connecting to the slot satisfy the fire enclosure requirements of IEC 62368-1.
- Do not install or remove the OPS PC or other devices from the accessory slot while the display is turned on. Ensure the power switch on the back of the display beside the AC power inlet is in the OFF (O) position.

Note

Unlike previous SMART Board interactive displays, the SMART Board 6000S and 6000S Pro series interactive displays don't require an iQ appliance in the accessory slot. The iQ experience is built into these interactive displays (see *iQ experience* on page 11). For this reason, SMART doesn't support installing iQ appliances in these displays' accessory slots. However, the AM50 appliance allows the use of an Intel Compute Card on the 6000S and SMART Board 6000S (C) models.

Convenience panel

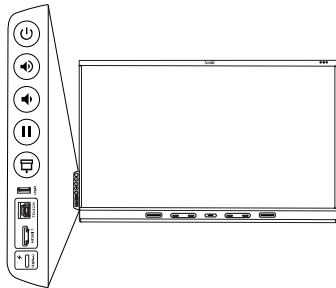

The convenience panel provides buttons for turning the display on and off, controlling the volume, freezing and unfreezing the screen, and showing and hiding a screen shade. It also includes connectors for USB peripherals and a computer or other input source (available connectors vary by model, see *Connecting room computers and guest laptops* on page 33).

Proximity sensor

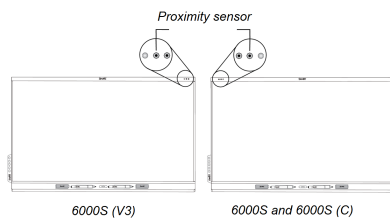

On SMART Board 6000S (V3) models, the proximity sensor is located in the top-right corner of the display's frame. On the 6000S and 6000S (C) models, the sensor is in the top-left corner.

The proximity sensor can detect people up to approximately 16' (5 m) away when the display is in an energy saving mode.

When the proximity sensor detects people in the room, the display turns on, depending on how it's configured.

If the room is empty for a specified period, the display returns to an energy saving mode.

Notes

- For more information on energy saving modes, see *About energy saving modes* on page 30.
- The proximity sensor on the SMART Board 6000S (V3) models responds when the display is in the networked standby and the standby power states. On the 6000S and 6000S (C) models, the proximity sensor responds only when the display is in the networked standby power state.
- The sensor can detect people through glass. Consider this when finding a location for the display (see *Installing the display on a wall* on page 22). Don't position the display so that the sensor is facing a window.

Ambient light sensor

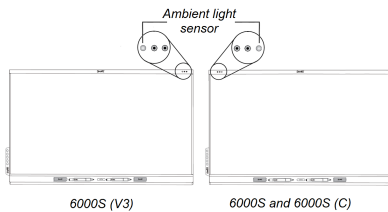

On SMART Board 6000S (V3) models, the ambient light sensor is located in the top-right corner of the display's frame. On the 6000S and 6000S (C) models, the sensor is in the top-left corner.

The ambient light sensor detects the room's brightness and adjusts the brightness of the screen accordingly.

You can enable, disable, and adjust this feature (see *Appendix A Adjusting settings* on page 59).

Remote control and IR sensor

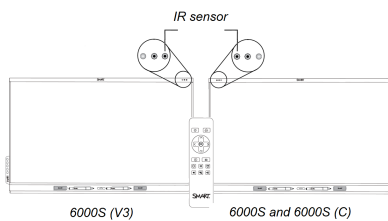

You can use the remote control to turn the display on and off, adjust display settings, and so on.

On SMART Board 6000S (V3) models, the IR sensor is located in the top-right corner of the display's frame. On the 6000S and 6000S (C) models, the sensor is in the top-left corner.

Temperature and humidity sensors

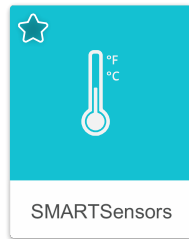

The display features integrated temperature and humidity sensors that can provide real-time measurement and recording of the display's environmental conditions. This data is easily accessible using the temperature and humidity app in the display's App library.

Note

Temperature and humidity sensors are available only when iQ is enabled.

Microphone array

This feature is available only on the SMART Board 6000S (V3) and SMART Board 6000S (V3) Pro models.



Note

The SMART Board 6400S (V3) Pro models do not include a microphone array.

You can use the display's built-in microphone array while using a conferencing app on the display. The microphone array provides improved sound detection. You can also use the display's built-in microphone array in place of a connected computer's microphone.

NFC sign in

The display allows you to sign in to your SMART Account using NFC (near field communication): just tap your SMART ID card on the screen and enter a PIN. This feature helps you save time signing in to your account without typing your username and password.

Note

NFC sign in is available only on SMART Board 6000S series displays with iQ. Only SMART ID cards are supported.

Mounting hardware

The display comes with a WM-SBID-200 wall mount, which you can use to mount the display on a wall (see *Installing the display on a wall* on page 22).

You can also mount the display on a wall or mobile stand (see *Accessories* on page 18).

Accessory mounting points

The display features M4 mounting points located at the top-left and top-right for SMART approved accessories.

Identifying your specific model

SMART offers a variety of models of the SMART Board 6000S and 6000S Pro series interactive display:

Model/SKUs	Frame style	Screen size (approximate)	iQ embedded computing	Microphone array
6000S (V3)				
SBID-6265S-V3	White	65"	Yes	Yes
SBID-6275S-V3	White	75"	Yes	Yes
SBID-6286S-V3	White	86"	Yes	Yes
SBID-6065S-V3	White	65"	No	Yes
SBID-6075S-V3	White	75"	No	Yes
SBID-6086S-V3	White	86"	No	Yes
6000 (V3) Pro				
SBID-6265S-V3-PW	White	65"	Yes	Yes
SBID-6275S-V3-PW	White	75"	Yes	Yes
SBID-6286S-V3-PW	White	86"	Yes	Yes
SBID-6065S-V3-PW	White	65"	No	Yes
SBID-6075S-V3-PW	White	75"	No	Yes
SBID-6086S-V3-PW	White	86"	No	Yes
SBID-6265S-V3-P	Black	65"	Yes	Yes
SBID-6275S-V3-P	Black	75"	Yes	Yes
SBID-6286S-V3-P	Black	86"	Yes	Yes
SBID-6065S-V3-P	Black	65"	No	Yes
SBID-6075S-V3-P	Black	75"	No	Yes
SBID-6086S-V3-P	Black	86"	No	Yes
SBID-6465S-V3-P	Black	65"	No	No
SBID-6475S-V3-P	Black	75"	No	No
SBID-6486S-V3-P	Black	86"	No	No

Model/SKUs	Frame style	Screen size (approximate)	iQ embedded computing	Microphone array
6000S (C)				
SBID-6265S-C	White	65"	Yes	No
SBID-6275S-C	White	75"	Yes	No
SBID-6286S-C	White	86"	Yes	No
SBID-6065S-C	White	65"	No	No
SBID-6075S-C	White	75"	No	No
SBID-6086S-C	White	86"	No	No
6000S (C) Pro				
SBID-6265S-CPW	White	65"	Yes	No
SBID-6275S-CPW	White	75"	Yes	No
SBID-6286S-CPW	White	86"	Yes	No
SBID-6065S-CPW	White	65"	No	No
SBID-6075S-CPW	White	75"	No	No
SBID-6086S-CPW	White	86"	No	No
6000S				
SBID-6265S	White	65"	Yes	No
SBID-6275S	White	75"	Yes	No
SBID-6286S	White	86"	Yes	No
SBID-6065S	White	65"	No	No
SBID-6075S	White	75"	No	No
SBID-6086S	White	86"	No	No
6000S Pro				
SBID-6265S-PW	White	65"	Yes	No
SBID-6275S-PW	White	75"	Yes	No
SBID-6286S-PW	White	86"	Yes	No
SBID-6065S-PW	White	65"	No	No
SBID-6075S-PW	White	75"	No	No
SBID-6086S-PW	White	86"	No	No
SBID-6065S-P	Black	65"	No	No

Model/SKUs	Frame style	Screen size (approximate)	iQ embedded computing	Microphone array
SBID-6075S-P	Black	75"	No	No
SBID-6086S-P	Black	86"	No	No

Refer to the specifications for detailed technical information for these models, including product dimensions and weights (see *More information* on the next page).

Accessories

Accessories for the display include:

- Pen accessory kit
- Tool Explorer-enabled objects and manipulatives
- SMART OPS PC module
- Stands
- USB extenders

Note

For more information about these and other accessories, see smarttech.com/accessories.

Pen accessory kit

The pen accessory kit includes blue, green, purple, and orange pens and a holder that you can mount on the side of the display.

Tool Explorer-enabled objects and manipulatives

The display's Tool Explorer platform enables you to use a range of different pens, objects, and manipulatives that are automatically recognized the moment they contact the display's screen.

Note

Support for the different pens, objects, and manipulatives varies depending on the model of display.

See the *SMART Board 6000S and 6000S Pro user guide* (smarttech.com/kb/171415)

SMART OPS PC module

SMART Open Pluggable Specification (OPS) PC modules provide a hassle-free Windows Pro installation based on Intel® Core™ processors and are designed specifically to work with a SMART display. All OPS PC modules are WHQL certified and fully licensed with Windows Pro. Install the OPS PC module in a display's accessory slot to provide a complete 4K UHD Windows installation at your fingertips, without the need for an external PC or additional cables.

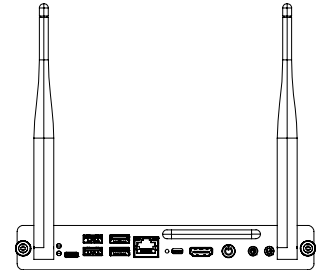

Install familiar Windows applications, such as SMART Notebook®, SMART TeamWorks™, and SMART Meeting Pro® software, and access the internet directly through your display's network connection. Upgrades and service for the OPS PC module are easy to perform without removing the display from its mounting.

Note

Refer to an application's specifications for information about its computer requirements.

Stands

If you want to move the display from place to place, you can install it on a SMART mobile stand. If you are installing the display on a wall that cannot support the display's full weight, you can install the display on a SMART floor stand.

USB extenders

As noted in the display's specifications, there is a maximum length for USB cable connections between the display and computer.

When using USB 2.0, the cable should be no longer than 16' (5 m).

When using USB 3.0, the cable should be no longer than 9' (3 m).

If you need a longer USB connection, use a USB extender. For more information, see [USB cable extenders](#).

More information

SMART provides a variety of other documents for this display in the Support section of the SMART website (smarttech.com/support). Scan the QR code on the cover of this guide to view links to SMART Board 6000S and 6000S Pro series interactive display documents and other support resources.

Chapter 2 Installing the display

Moving the display to the installation site	20
Using transportation aides	21
Accommodating doorways, hallways, and elevators	21
Dealing with cracked, chipped, or shattered glass	22
Saving the original packaging	22
Installing the display on a wall	22
Choosing a location	23
Choosing a height	25
Assessing the wall	25
Selecting mounting hardware	25
Selecting a wall mount	25
Mounting the display	26
Mounting multiple displays	26
Installing the display on a stand	27
Using SMART mobile stands	27
Using a third-party stand	27
Connecting to a network	28
Connecting power and turning on the display for the first time	29
About energy saving modes	30

SMART recommends that only trained installers install the display.

This chapter is for installers. Installers should read this information along with the installation instructions included with the display before they begin the installation.

Warning

Improper installation of the display can result in injury and product damage.

Moving the display to the installation site

After your organization receives the display, you need to move it to the place where you plan to install it.

On occasion, you might also need to move the display to another location after initially installing it.

! **Important**

- Move the display at your own risk. SMART cannot accept liability for damages or injury that occur during the display's transportation.
- When moving the display:
 - Follow local safety regulations and standards.
 - Pack the display in its original packaging, including the pallet.
 - Move the display so that its top frame faces up.
 - Have at least two people move the display.

Tip

Display packaging may be labeled to indicate which side is the front. Look for "FRONT" on the packaging to help orient the box during transportation.

Using transportation aides

You can use the following aides to move the display:

- Cart
- Furniture dolly
- Mechanical lift

Accommodating doorways, hallways, and elevators

In some situations, you might need to remove the display from its packaging to move it through narrow doorways or hallways or onto an elevator. In these situations, keep the foam pieces on the bottom corners of the display. These foam pieces protect the display if you need to set it down during transportation.

You might also need to rotate the display so that its top frame faces to the side. You can do this during transportation, but when you install the display, it must be in landscape orientation (with the top frame facing up).

Dealing with cracked, chipped, or shattered glass

The display contains safety-tempered glass. Although this glass is heat-strengthened to help withstand impacts, the glass can crack, chip or shatter if struck with enough force. (Safety glass is designed to break into small pieces rather than sharp shards if it is broken.) Temperature changes can cause a minor crack or chip to become worse, possibly causing the glass to shatter. See the knowledge base article, [Shattered glass on an interactive display](#), for information about conditions that can cause the display's glass to shatter even when it's not in use.

If the display's glass is cracked or chipped, have it professionally inspected and repaired at a SMART authorized repair center. If the display's glass shatters, carefully clean up the area and have the display repaired or replaced.

Warning

For safety and to prevent further damage, do not continue to install or use the display if its glass is cracked, chipped or shattered.

Saving the original packaging

Save the original packaging and repack the display with as much of it as possible if you ever need to move the display after installation. This packaging was designed to provide the best possible protection against shock and vibration.

Note

If the original packaging isn't available, you can purchase the same packaging directly from your authorized SMART reseller (smarttech.com/where).

Caution

Move the display only in the original packaging or replacement packaging purchased from your authorized SMART reseller. Moving the display without correct packaging can lead to product damage and voids the warranty.

Installing the display on a wall

Typically, you install the display on a wall in a classroom or meeting space.

Choosing a location

A display is typically installed at the room’s focal point, such as at the front of a classroom or meeting space.

Selecting an appropriate location for the display is crucial for ensuring the best possible experience with the product. Consider the following factors as you choose a location:

Factor	Considerations
Room setup	<ul style="list-style-type: none"> • The location allows users, including those in wheelchairs, access to the display. Refer to local regulations regarding accessibility. • The location allows for multiple users to access the display at the same time. • The location accommodates room traffic patterns, and there are no tripping hazards. • The display is not installed where it could be hit by a door or gate. • There are no nearby heat sources directed at the display, such as a radiator or heat vent. • There are no nearby shelving units, desks, or other furniture that has doors or drawers that could hit the display. • Furniture, wall décor, and other room features, such as light switches and thermostats, do not block the display and are not blocked by it. (You might be able to move some of these room features to accommodate the display.)
Power and other connections	<ul style="list-style-type: none"> • The location is close to: <ul style="list-style-type: none"> ◦ A power outlet ◦ A network outlet (if you plan to use a wired network connection) ◦ A room computer (if you plan to connect a room computer) ◦ External audio systems and other devices that you want to connect to the display <p>Notes</p> <ul style="list-style-type: none"> ◦ If the location is not near a power outlet, consult an electrician for the power setup you need. ◦ Determine if you’ll need additional equipment, such as power bars, additional cables, or cable extenders. <ul style="list-style-type: none"> • The location is not where the mains power supply enters the building.

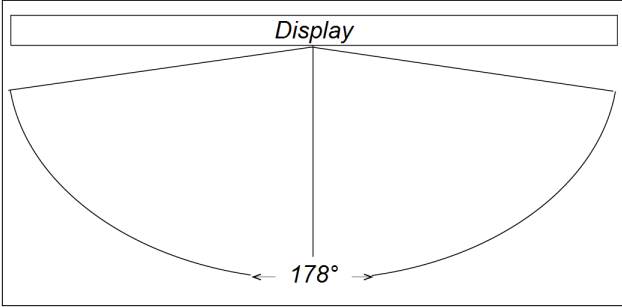
Factor	Considerations
<p>Visibility</p>	<p>The display's screen is clearly visible to all users in the room. SMART recommends users sit within a 178° viewing area:</p>  <p>Note</p> <p>The viewing area depends on the display's resolution and a variety of other factors. For more information, see the knowledge base article, Recommended viewing distances and viewing angles for SMART Board interactive displays.</p>
<p>Lighting</p>	<p>The location is not near bright light sources, such as windows or strong overhead lighting.</p> <p>Light sources can cause glare on the display's screen, reducing its visibility. Sources of strong infrared light can also affect the display's touch system.</p> <p>Tip</p> <p>To reduce light interference, install blinds or shades on windows or skylights and install switches to dim or turn off any lights shining directly on the display's screen. Keep in mind that sunlight can come through windows at different angles at different times of the year.</p>
<p>Acoustics</p>	<p>The room has good acoustics (see Configuring your SMART Board 6000S for the best audio performance).</p>
<p>Environment and ventilation</p>	<ul style="list-style-type: none"> • The location meets the environmental requirements in the display's specifications (see <i>More information</i> on page 19). • The display isn't subjected to strong vibrations or dust. • Ventilation systems don't blow air directly on the display. • There is adequate ventilation or air conditioning around the display so that heat can flow away from it and the mounting equipment. SMART recommends at least 2" (5 cm) of space on all sides of the display for proper airflow. • If you plan to install the display in a recessed area, there is at least 4" (10 cm) of space between the display and the recessed walls to enable ventilation and cooling.

Choosing a height

Consider the general height of the user community when you choose the height for the display.

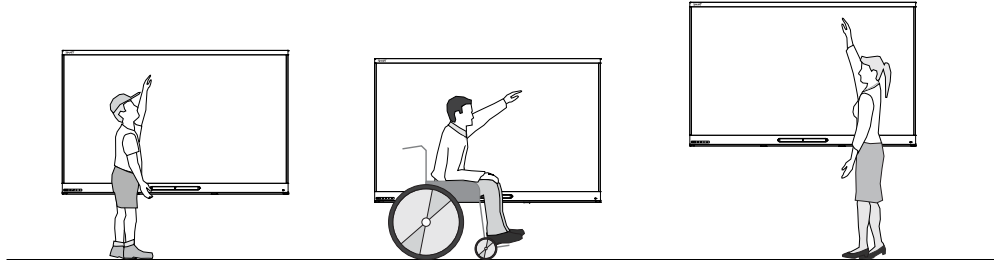

SMART recommends that you mount the display so that its top is 6' 5" (1.9 m) from the floor.

Note

If participants will be sitting at a steep angle (such as in a lecture hall), you may have to adjust the installation height or angle.

Assessing the wall

Be sure the wall you're installing the display on can support the weight of the display and mounting equipment. If it can't, consider using a SMART wall stand to transfer some of the weight from the wall to the floor (see smarttech.com/accessories).

Note

Refer to the display's specifications for its weight (see *More information* on page 19).

In some situations, you may need to request an engineering analysis to determine if the wall can support the display.

Selecting mounting hardware

The mounting hardware required for installation varies according to the type of wall onto which the display is being mounted.

If you're using the SMART wall mount (WM-SBID-200), see the wall mount's illustrated installation instructions for information about the required mounting hardware (smarttech.com/kb/171373).

Selecting a wall mount

It is always best to mount the display on a wall. If the wall can't support the display's weight, you can use additional hardware to transfer some of the weight to the floor.

The display comes with a WM-SBID-200 wall mount. SMART recommends using this wall mount to install the display on a wall.

If you choose a third-party option rather than one of SMART's mounting options, be sure the wall mount can accommodate the display's dimensions and support the display's weight as well as the weight of any attached accessories.

Mounting the display

Mount the display following the included installation instructions. In addition, consider the following:

- Mount the display vertically (90° relative to the floor plus or minus 2° for tolerance) and in landscape orientation. SMART doesn't support mounting the display at other angles or in portrait orientation.

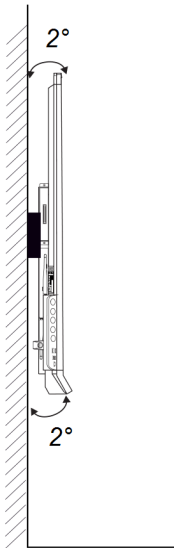

- Use M8 bolts included with the wall mount to fasten the bracket.

Caution

Do not over-tighten the bolts. Use 97.36–177.01 in-lb. (11–20 N·m) fasten force.

- Because the display's receptacles might not be easily accessible after you mount the display, consider connecting cables for power, room computer, and other devices before mounting the display (see *Chapter 3 Connecting computers and other devices* on page 31).

Mounting multiple displays

This feature is not available on the SMART Board 6000S (V3) and SMART Board 6000S (V3) Pro interactive displays.



If you mount multiple displays side by side, you can connect them with RS-232 cables to turn on, turn off, and otherwise operate all of the displays from the first display's convenience panel.

The leftmost display (when viewed from the front) is the first display:

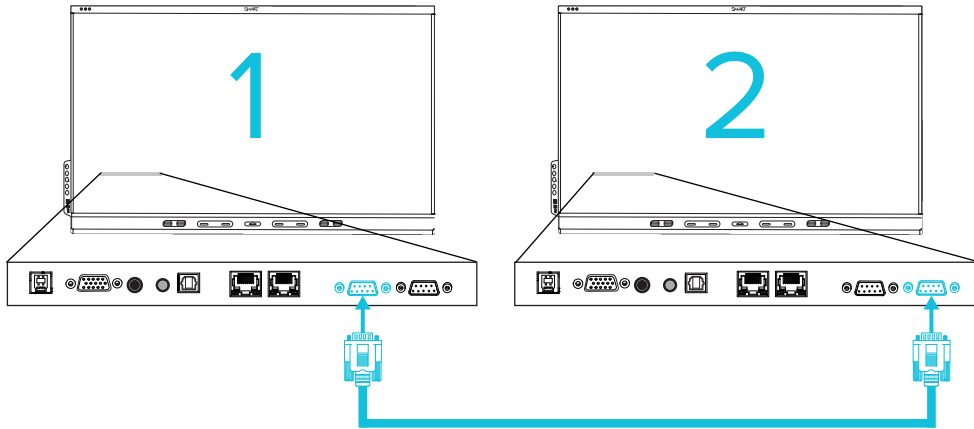

! **Important**

Use only standard RS-232 cables. Do not use null modem cables.

Note

For more information about using RS-232 cables for remote management, see *Appendix D Managing SMART Board 6000S (C) or 6000S series displays using RS-232* on page 82.

Installing the display on a stand

If you want to move the display from place to place or if it's not possible to install the display on a wall, you can install it on a stand.

Using SMART mobile stands

SMART mobile stands are designed for SMART interactive displays. They are height-adjustable. Some models include integrated speakers, a locking cabinet to secure equipment, and casters that swivel and lock for easy movement.

For more information about SMART mobile stands, see smarttech.com/accessories.

Using a third-party stand

For information on selecting and using a third-party stand, see [Installing your SMART Board 6000S on a stand](#).

Connecting to a network

The display requires a network and internet connection for downloading software and firmware updates, and a number of the iQ apps require a network connection as well. You can connect to the network via Wi-Fi or to a router using Wi-Fi or one of the RJ45 jacks.

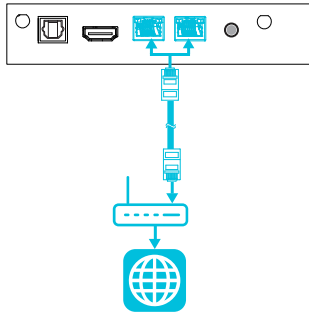

SMART Board 6000S (V3)

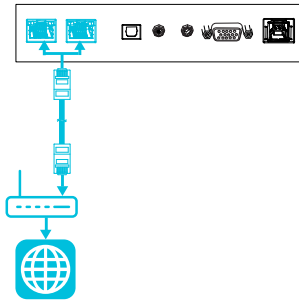

SMART Board 6000S and 6000S (C)

Tip

If you're using one of the display's RJ45 jacks to connect to a network, you can connect a computer to the other RJ45 jack to provide network access for the computer (pictured). This is particularly useful if there is only one wired network connection in the room. Network access is available when Networked Standby is enabled in Settings but not when Standby is enabled in Settings.

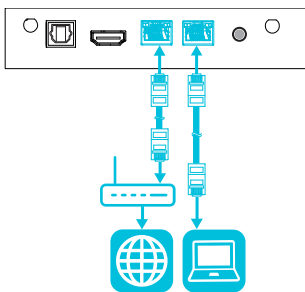

SMART Board 6000S (V3)

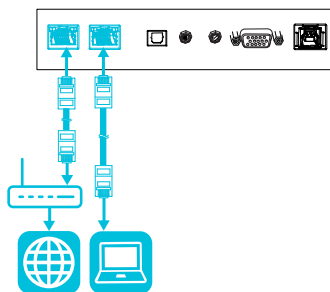

SMART Board 6000S and 6000S (C)

For more information about the display's network connection and configuration, see [Connecting a SMART display with the iQ experience to a network](#).

Connecting power and turning on the display for the first time

The final step in installing and configuring the display is to connect power and turn it on. When you first turn on the display, a setup wizard appears. Follow the steps in the wizard to complete the setup.

To connect the display to power

Connect the supplied power cable from the AC power inlet on the back of the display to a power outlet.

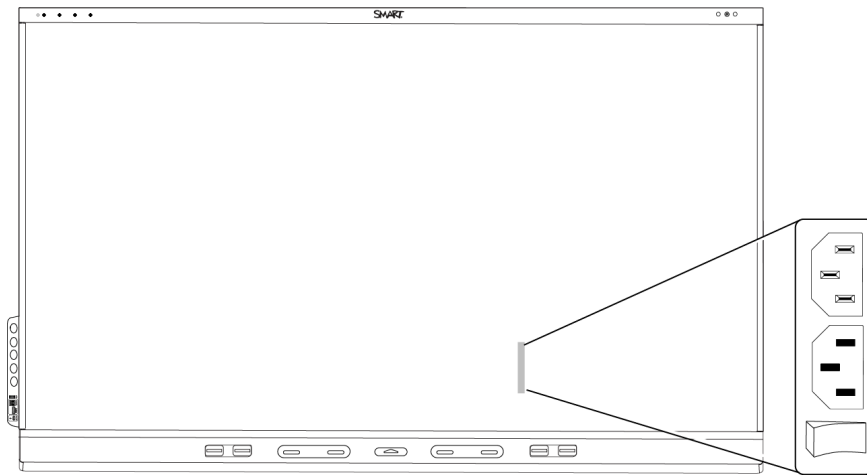

Notes

- Refer to the display's specifications for power requirements and power consumption information (see *More information* on page 19).
- The AC power output on the back of the display is rated at 250 W.

To turn on and set up the display for the first time

! Important

Install the OPS PC module before you turn the display on.

Note

If a USB drive is connected to the display's service port, do not remove the USB drive. The USB drive contains an important firmware update.

1. Flick the switch beside the AC power inlet to the ON (I) position.
2. Press the **Power** button  on the front control panel or remote control

3. Select your preferred language, and then tap **Next**.
4. Select your country, and then tap **Next**.
5. Select your time zone, and then tap **Next**.
6. Set the date, and then tap **Next**.
7. Set the time, and then tap **Next**.
8. Name the display, and then tap **Next**.
9. If the display isn't using a wired network connection, select a wireless network, and then tap **Next**.

 **Important**

The display needs an internet connection for downloading and installing important updates. Ask the network administrator to confirm that the network has been correctly configured for the iQ experience. For more information about network configuration, see [Connecting a SMART display with the iQ experience to a network](#).

Note

If an internet connection is not available for downloading and installing important updates, see [Updating system software manually](#) on page 50.

10. Select the apps you want to appear in the Apps Library, and then tap **Next**.

Tip



To change which apps appear in the Apps Library, see [Launcher](#) on page 61.

11. Tap **Finish**.

The *Welcome* screen appears.

About energy saving modes

The display features a number of energy saving modes:

- Networked standby: a low power state in which the display quickly turns on when the Power button  is pressed or the proximity sensor detects people in the room.
- Standby: a very low power state in which the display turns on when the Power button  is pressed. The proximity sensor doesn't turn the display on in this power state.

Standby is the default energy saving mode for displays set to a location within the EU. Elsewhere, networked standby is the default energy saving mode. You can select the display's energy saving mode in **Settings > System Settings > Power > Standby (Shutdown)** or **Settings > System Settings > Power > Networked Standby (Sleep)**.

Chapter 3 Connecting computers and other devices

- Installing SMART software 31
- Connecting room computers and guest laptops 33
 - Viewing a connected computer’s input 34
 - Setting a connected computer’s resolution and refresh rate 35
 - Using recommended cables 35
 - Connecting USB drives, peripherals, and other devices 36
 - Troubleshooting connected computers 36
- Connecting a SMART OPS PC module 36
- Connecting other devices 36
 - Connecting USB drives, peripherals, and other devices 37
 - Connecting an external display 37
 - Connecting an external audio system 38
 - Connecting room control systems 39
- Connector diagrams 40
 - SMART Board 6000S (V3) connector panel 40
 - SMART Board 6000S (C) and 6000S connector panel 42
 - Convenience panel 43

 **Warning**

Ensure that any cables that cross the floor to the display are properly bundled and marked to avoid a trip hazard.

Installing SMART software

The display comes with the following software, which you can install on connected computers:

Software	Description	Notes
SMART Notebook	Free software designed for use with a SMART Board interactive display. SMART Notebook software comes with many features that you can use to create, edit, and deliver engaging lessons for your students.	See SMART Notebook .

Software	Description	Notes
SMART Meeting Pro	Software that enables you to capture ideas in a virtually unlimited interactive workspace.	Pro models only.
SMART Product Drivers	Software that enables the computer to detect input from the display.	Included with SMART Notebook and SMART Meeting Pro software
SMART Ink	Software that enables you to write and draw in digital ink over applications, files, folders, websites, and any other open window.	Included with SMART Notebook and SMART Meeting Pro software
SMART Remote Management	Cloud-based mobile device management software for remotely maintaining, supporting, controlling, and securing the display and your other devices.	Subscription for length of the included warranty ¹

Tip

You can purchase additional licenses or subscriptions to SMART software to install on other computers.

The following software is also available but sold separately:

Software	Description	Licensing details
SMART Learning Suite	A suite of desktop and online software that combines lesson delivery, activities, assessments, and collaborative workspaces. Includes SMART Notebook Plus software and Lumio™ by SMART.	Single and group plan subscriptions available. See smarttech.com/lumio/pricing .
SMART TeamWorks Room	Software that simplifies meetings and facilitates deeper, more natural interaction with on-site and remote participants.	1-year subscription ²

Contact your authorized SMART reseller (smarttech.com/where) for information about purchasing SMART software.

You can download SMART software from smarttech.com/downloads and install it following the instructions in [Installing and maintaining SMART Notebook](#), [Installing SMART TeamWorks](#), or [Installing and maintaining SMART Meeting Pro](#).

¹Subscription terms may vary in some regions.

²Pro models only.

Connecting room computers and guest laptops

You can connect cables for room computers and guest laptops. By installing cables in advance, you make use of connectors that might not be accessible after the display is mounted on the wall. You can then run the cables across floors or behind walls as needed.

Connector panel

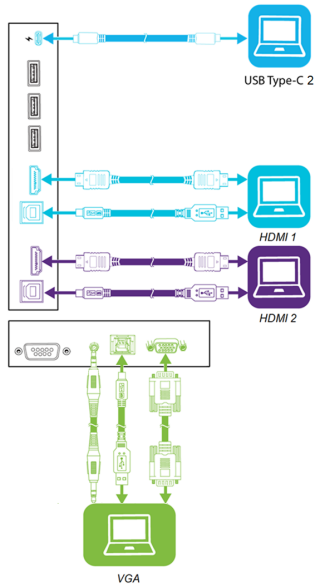

SMART Board 6000S (V3)

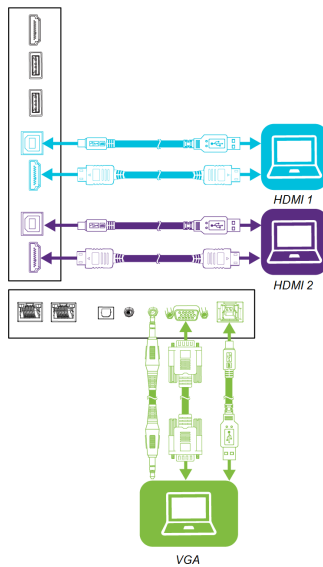

SMART Board 6000S and 6000S (C)

Convenience panel

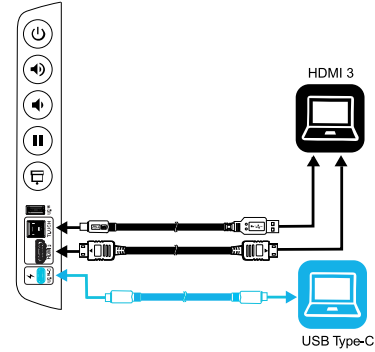

SMART Board 6000S (C) and 6000S (V3)

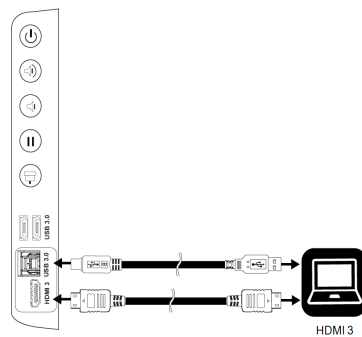

SMART Board 6000S

Note

- Install SMART software on computers you connect to the display (see *Installing SMART software* on page 31).
- You can charge devices connected to the USB Type-C receptacles. SMART Board 6000S (V3) models can provide up to 65 W to connected devices (the USB Type-C receptacle labeled USB-C 2 on the rear connector panel provides 30 W when an OPS PC module is installed). The USB Type-C receptacle on SMART Board 6000S (C) models can provide up to 60 W.
- A computer may report "Too many USB hubs" if USB port replicators, hubs, or extensions are used between a computer and a SMART Board interactive display. To learn why this message appears, see the knowledge base article, [SMART Board interactive displays and USB tier structure use](#). This article also describes the number and position of internal hubs in SMART Board 6000S/6000S-C/6000S-V3 displays.

Viewing a connected computer's input

Use the Input app to view a connected computer's input on the display.

To view a connected computer's input

1. Connect the computer to the display.
2. Do one of the following:

If iQ is enabled

Tap **Input**  on the Home screen.

OR

Press **Input**  on the remote control.

If iQ is disabled

Press the **Home** button  or the **Input** button  on the remote control.

The display shows thumbnails of the devices that are connected to the display:

- A grey thumbnail indicates no device is connected to an input.
- A black thumbnail indicates a device is connected to an input but is in Sleep mode.
- A thumbnail showing a preview screen indicates an active device is connected to an input.

Tip

If iQ is disabled and you want a computer's input to appear whenever you wake up the display, tap the star in the upper-left corner of the computer's thumbnail.

3. Tap the computer's thumbnail.

Setting a connected computer's resolution and refresh rate

This table presents the recommended resolutions and refresh rates for the display's inputs:

Input source	Resolution	Refresh rate
HDMI 1	3840 × 2160	60 Hz
HDMI 2	3840 × 2160	60 Hz
HDMI 3	3840 × 2160	60 Hz
VGA	1920 × 1080	60 Hz
USB Type-C	3840 × 2160	60 Hz

If possible, set connected computers to these resolutions and refresh rates. See the computers' operating system documentation for instructions.

Using recommended cables

SMART recommends the following varieties of cable:

Cable type	Maximum length	Recommendation
HDMI	23' (7 m) ³	Use only certified premium high-speed HDMI cables that have been tested to support the performance standard you require.
VGA	23' (7 m)	Use VGA cables with all pins in their connectors fully populated and wired.
Stereo 3.5 mm	20' (6 m)	[N/A]
USB 2.0	16' (5 m)	Use a USB extender if the distance between the computer and the display is greater than 16' (5 m). For more information, see <i>USB extenders</i> on page 19. USB 2.0 cables support Hi-Speed (480 Mbps), whether connected to a USB 2.0 or USB 3.0 receptacle. For SuperSpeed (5 Gbps), connect a USB 3.0 cable to a USB 3.0 receptacle.
USB 3.0	9' (3 m)	SMART supports only installations that use directly connected video and USB cables, AC-powered extenders, or USB extenders purchased from SMART. You might be able to use higher-grade cables that are longer than specified. If you have problems with such a cable or an extender of any type, test the connection with a shorter cable before contacting SMART Support.

³The performance of cables longer than 23' (7 m) is highly dependent on the cable's quality.

Cable type	Maximum length	Recommendation
USB Type-C	6' 6" (2 m) for SuperSpeed 5Gbps cables	USB-IF certified USB 3.2 Gen 1 Type-C cable, SuperSpeed (5 Gbps) support To use a USB Type-C cable for video, you need: <ul style="list-style-type: none"> • A full-featured cable that supports SuperSpeed 5Gbps (or faster) data rates. • A computer that supports Display Port Alternate Mode via USB Type-C

Using cables that exceed these maximum lengths may produce unexpected results, degraded picture quality or degraded USB connectivity.

Connecting USB drives, peripherals, and other devices

You can use USB drives, peripherals, and other devices with a computer connected to the display using the display's USB plugs.

For more information, see *Connecting USB drives, peripherals, and other devices* on the next page.

Troubleshooting connected computers

For troubleshooting information for connected computers, see *Chapter 5 Troubleshooting* on page 51.

Connecting a SMART OPS PC module

If your organization has purchased a SMART OPS PC module, you or your organization's installers can install the OPS PC module in the display's accessory slot following the OPS PC module's installation instructions (smarttech.com/kb/171544). You can then view the OPS PC module's input on the display.

For more information about SMART OPS PC modules, see the *SMART OPS PC modules user guide* (smarttech.com/kb/171747).

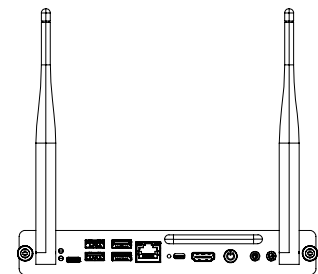

Connecting other devices

In addition to computers, you can connect the following devices to the display:

- USB drives, peripherals, and other devices
- External displays

- External audio systems
- Room control systems

Connecting USB drives, peripherals, and other devices

Depending on the model, the display includes either one USB Type-C receptacle and one USB 3.0 Type-A receptacle on the convenience panel, or two USB 3.0 Type-A receptacles on the convenience panel (see images below). The SMART Board 6000S (V3) models also include a USB Type-C receptacle on the connector panel. All models include one USB 3.0 Type-A receptacle on the connector panel.

You can connect USB drives, peripherals (such as keyboards), and other devices to these connectors and use the devices with the iQ experience, connected computers, and devices installed in the accessory slot, such as the SMART OPS PC.

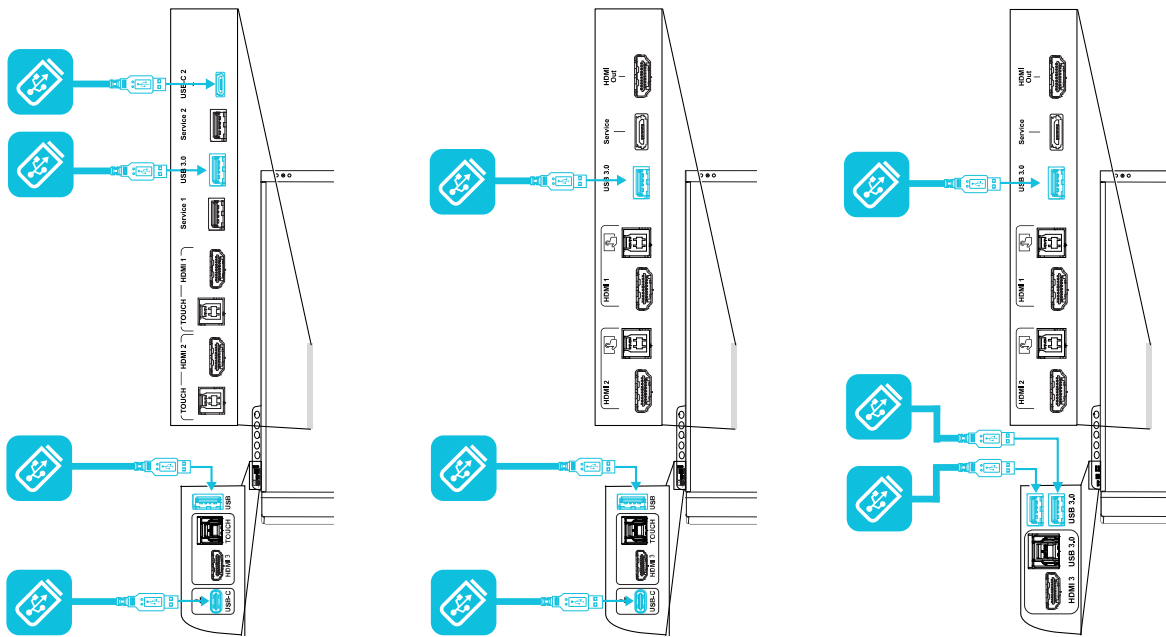

SMART Board 6000S (V3)

SMART Board 6000S (C)

SMART Board 6000S

Connecting an external display

You can connect an external display using the HDMI 2.0 out connector on the connector panel (pictured). The external display will show the same image. This is useful when you're using the display in an auditorium or other large space where it would be beneficial to have a second display.

Note

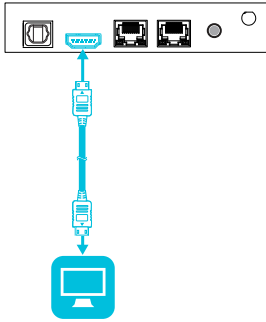

SMART Board 6000S (V3)

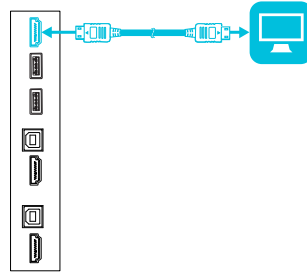

SMART Board 6000S and 6000S (C)

! Important

If the connected external display doesn't support HDCP, the image on the external display is limited to 480p resolution. For full resolution output, connect a display that supports HDCP.

Connecting an external audio system

The display includes two speakers, which are designed to provide sound at the front of a room. You might want to connect an external audio system if you're providing sound in a larger space.

You can connect an external audio system to the display using the stereo 3.5 mm out connector (pictured). This disables the display's internal speakers. Alternatively, you can connect an external audio system directly to a room computer.

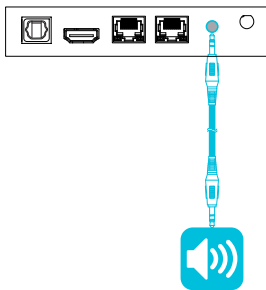

SMART Board 6000S (V3)

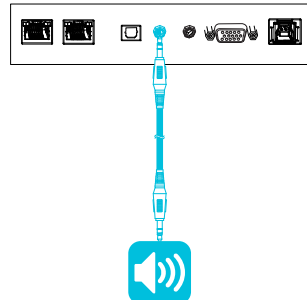

SMART Board 6000S and 6000S (C)

In addition to the stereo 3.5 mm out connector, the display provides a Sony/Philips Digital Interface (S/PDIF) out connector (pictured). S/PDIF is a digital audio transmission medium. You need an audio system that has an S/PDIF input to decode this connection to analog. Most external sound bars include a S/PDIF connector.

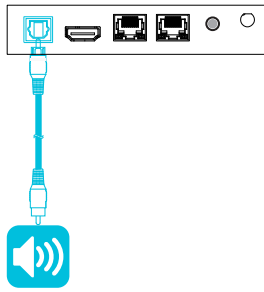

SMART Board 6000S (V3)

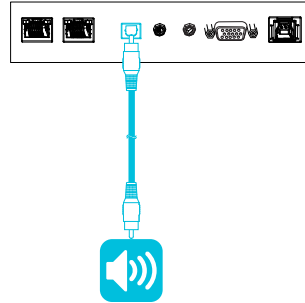

SMART Board 6000S and 6000S (C)

Notes

- If you connect an external speaker system to the display using the Sony/Philips Digital Interface (S/PDIF) out connector and the audio source device is connected to the display using an HDMI 2.0 connection, the external speaker system must support HDCP 2.2. For more information, see [SMART Board interactive flat panels and High-bandwidth Digital Content Protection \(HDCP\)](#).
- The S/PDIF audio is a fixed-volume output. Adjusting the display's volume for its internal speakers does not affect the volume output of the S/PDIF port.

Connecting room control systems

A room control system enables users to control a room's lighting, audio system and, possibly, the display. Some installations may require you to integrate the display with a room control system.

You can use the display's RS-232 connector to connect a third-party external control system to the display (see [Appendix D Managing SMART Board 6000S \(C\) or 6000S series displays using RS-232](#) on page 82 or [Appendix C Managing the SMART Board 6000S \(V3\) display using RS-232](#) on page 74).

Note

Displays are not compatible with centralized remote control systems, such as a universal remote control.

Connector diagrams

SMART Board 6000S (V3) connector panel

The following diagram and table present the connectors on the display's connector panel:

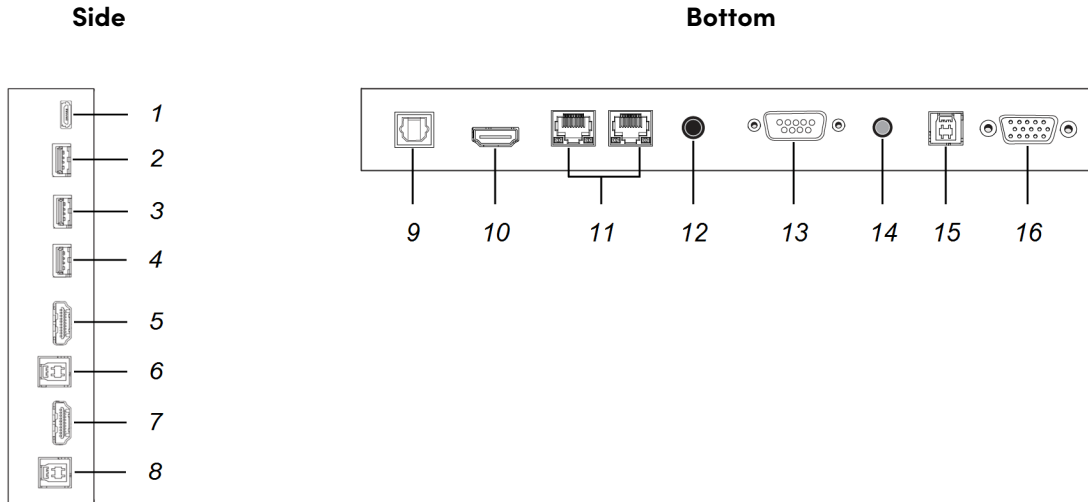

No.	Connector	Connects to	Notes
1	USB Type-C	USB-C 2 input	See page 33 and USB cables and connectors .
2	USB 3.0 Type-A	[N/A]	This connector is a service port (2).
3	USB 3.0 Type-A	Supported USB drives, peripherals, and other devices	See <i>Connecting USB drives, peripherals, and other devices</i> on page 37 and USB cables and connectors .
4	USB 2.0 Type-A	[N/A]	This connector is a service port (1).
5	HDMI 2.0 in	HDMI 1 input (video and audio)	See page 33 and HDMI cables and connectors .
6	USB 3.0 Type-B	HDMI 1 input (touch)	See page 33 and USB cables and connectors .
7	HDMI 2.0 in	HDMI 2 input (video and audio)	See page 33 and HDMI cables and connectors .
8	USB 3.0 Type-B	HDMI 2 input (touch)	See page 33 and USB cables and connectors .
9	S/PDIF out	Digital audio output	See page 38 and Digital audio cables and connectors .

No.	Connector	Connects to	Notes
10	HDMI 2.0 out	External display	See <i>Connecting an external display</i> on page 37 and <u>HDMI cables and connectors</u> .
11	RJ45 (×2)	Network	See page 28 and <u>Ethernet (network) cables and connectors</u> .
12	Stereo 3.5 mm out	External audio system	See page 38 and <u>Analog audio cables and connectors</u> .
13	RS-232	Room control system	See <i>Appendix C Managing the SMART Board 6000S (V3) display using RS-232</i> on page 74 and <u>RS-232 cables and connectors</u> .
14	Stereo 3.5 mm in	VGA input (audio)	See page 33 and <u>Analog audio cables and connectors</u> .
15	USB 3.0 Type-B	Touch input	See page 33 and <u>USB cables and connectors</u> .
16	VGA	VGA input (video)	See page 33 and <u>VGA cables and connectors</u> .

SMART Board 6000S (C) and 6000S connector panel

The following diagram and table present the connectors on the display's connector panel:

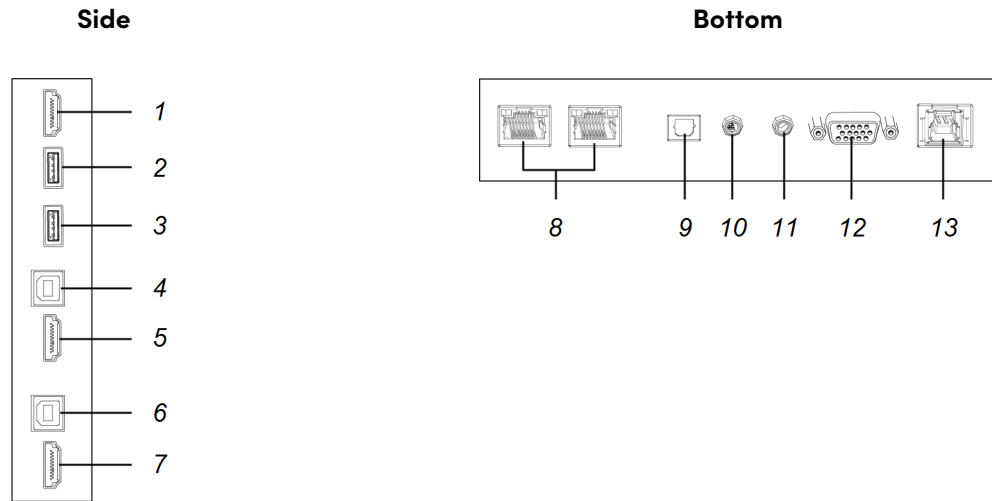

No.	Connector	Connects to	Notes
1	HDMI 2.0 out	External display	See <i>Connecting an external display</i> on page 37 and <u>HDMI cables and connectors</u> .
2	USB 2.0 Type-A	[N/A]	This connector is a service port.
3	USB 3.0 Type-A	Supported USB drives, peripherals, and other devices	See <i>Connecting USB drives, peripherals, and other devices</i> on page 37 and <u>USB cables and connectors</u> .
4	USB 3.0 Type-B	HDMI 1 input (touch)	See page 33 and <u>USB cables and connectors</u> .
5	HDMI 2.0 in	HDMI 1 input (video and audio)	See page 33 and <u>HDMI cables and connectors</u> .
6	USB 3.0 Type-B	HDMI 2 input (touch)	See page 33 and <u>USB cables and connectors</u> .
7	HDMI 2.0 in	HDMI 2 input (video and audio)	See page 33 and <u>HDMI cables and connectors</u> .
8	RJ45 (x2)	Network	See page 28 and <u>Ethernet (network) cables and connectors</u> .
9	S/PDIF out	Digital audio output	See page 38 and <u>Digital audio cables and connectors</u> .

No.	Connector	Connects to	Notes
10	Stereo 3.5 mm out	External audio system	See page 38 and Analog audio cables and connectors .
11	Stereo 3.5 mm in	VGA input (audio)	See page 33 and Analog audio cables and connectors .
12	VGA in	VGA input (video)	See page 33 and VGA cables and connectors .
13	USB 3.0 Type-B	VGA input (touch)	See page 33 and USB cables and connectors .

Convenience panel

The following diagram and table present the connectors on the display's convenience panel:

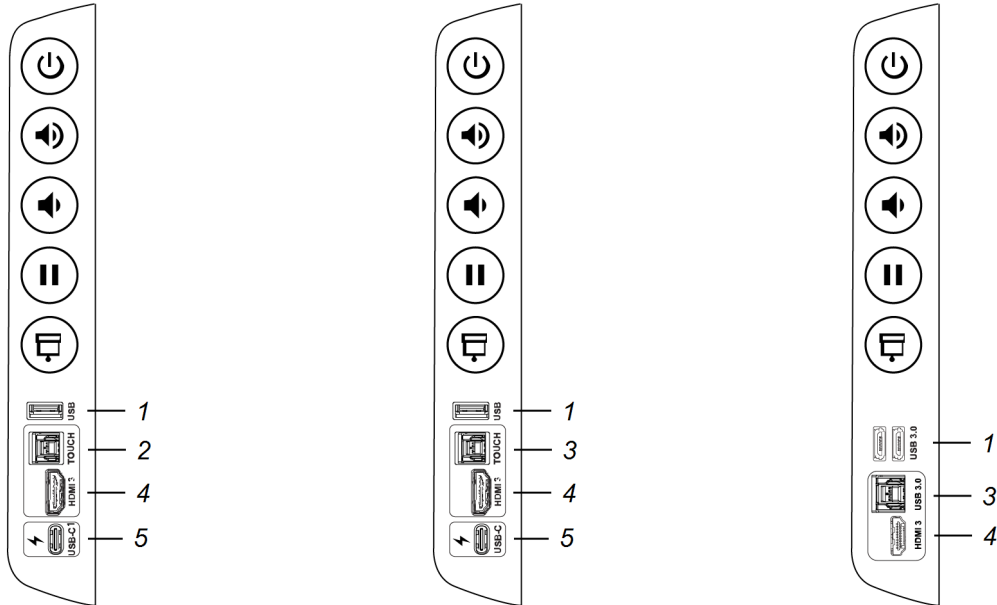

No.	Connector	Connects to	Notes
1	USB 3.0 Type-A ⁴	Supported USB drives, peripherals, and other devices	See <i>Connecting USB drives, peripherals, and other devices</i> on page 37 and USB cables and connectors .

⁴SMART Board 6000S (C) and 6000S (V3) models feature one USB 3.0 Type-A connector. All other models feature two USB 3.0 Type-A connectors.

No.	Connector	Connects to	Notes
2	USB 2.0 Type-B	HDMI 3 input (touch)	See page 33 and USB cables and connectors .
3	USB 3.0 Type-B	HDMI 3 input (touch)	See page 33 and USB cables and connectors .
4	HDMI 2.0 in	HDMI 3 input (video and audio)	See page 33 and HDMI cables and connectors .
5	USB Type-C ⁵	USB-C	See page 33 and HDMI cables and connectors .

⁵SMART Board 6000S (C) and 6000S (V3) models.

Chapter 4 Maintaining the display

Turning off, turning on, and resetting the display	45
Cleaning and maintaining hardware	46
Checking the display installation	46
Cleaning the screen	46
Cleaning the touch sensors	47
Cleaning Tool Explorer-enabled tools and manipulatives	47
Maintaining ventilation	48
Preventing condensation	48
Replacing the pens and erasers	48
Removing and transporting the display	49
Updating system software	50
Applying an automatic system software update manually	50
Updating system software manually	50

With proper maintenance, the display will provide years of use.

Turning off, turning on, and resetting the display

In most situations, you can put the display in an energy saving mode when not using it following the instructions in the *SMART Board 6000S and 6000S Pro series interactive displays user guide* (smarttech.com/kb/171415).

In some situations, such as when you transport the display or clean its screen, you need to turn the display off. You can turn it back on after.

You can also reset the display.

To turn the display off

1. Press the **Power** button  on the convenience panel or the remote control for five seconds.
A slider appears on the screen.
2. Move the slider to the right.

3. Flick the switch beside the AC power inlet to the OFF (O) position.

Note

Wait at least 30 seconds before turning the display back on.

To turn the display back on

1. Flick the switch beside the AC power inlet to the ON (I) position.
2. Press the **Power** button  on the convenience panel or the remote control.

To reset the display

Press and hold the **Power** button  on the convenience panel or the remote control for 10 seconds.

Note

Resetting the display does not change any user settings or delete saved files.

The display resets.

Cleaning and maintaining hardware

Checking the display installation

Inspect the display installation frequently to ensure that the display remains securely installed.

- Check the mounting location for signs of damage or weakness that can occur over time.
- Check for loose screws, gaps, distortions, or other issues that could occur with the mounting hardware.

If you find an issue, contact a trained installer.

Cleaning the screen

Follow these instructions to clean the screen without damaging its anti-glare coating or other product components.

 **Caution**

- Do not use permanent or dry-erase markers on the screen. If dry-erase markers are used on the screen, remove the ink as soon as possible with a lint-free, non-abrasive cloth.
- Do not rub the screen with dense or rough material.

- Do not apply pressure to the screen.
- Do not clean the screen using cleaning solutions or glass cleaners that are not approved by SMART. Non-approved cleansers can cause deterioration or discoloration of the screen.

To clean the screen

1. Turn off the display (see *Turning off, turning on, and resetting the display* on page 45).
2. Wipe the screen with a lint-free, non-abrasive cloth.

Note

You can also use a damp cloth with a drop of dish soap, or follow the instructions in the knowledge base article, [How to clean SMART Board surfaces and accessories](#).

Cleaning the touch sensors

The display uses infrared (IR) transmitters and sensors around the display's perimeter between the screen and the frame. Dust buildup on the protective plastic can impair touch performance. Inspect these areas for dust and clean them every week.

Caution

- Do not use compressed air to clean the sensors or borders.
- Do not use water or cleaning agents to clean the touch sensors.
- Do not apply too much pressure when cleaning the display because you can damage the plastic

To clean the IR transmitters and sensors

1. With a clean lint-free, non-abrasive cloth, gently wipe the plastic between the screen and the frame around the perimeter of the display's screen.
2. If dirt still remains, use 50% isopropyl alcohol (IPA) to clean the protective plastic between the screen and the frame.

Cleaning Tool Explorer-enabled tools and manipulatives

Follow these instructions to clean the Tool Explorer-enabled pens, objects, and manipulatives.

Caution

- Do not remove any of the labels from the tools or manipulatives.
- Do not submerge the tools or manipulatives in cleaning solutions or water.

To clean the Tool Explorer-enabled tools and manipulatives

1. With a clean lint-free, non-abrasive cloth, gently wipe the surface of the tool or manipulative.
2. If dirt still remains, clean the surfaces of the tool or manipulative using 70–90% isopropyl alcohol (IPA) or a solution of 10 parts distilled water to one part standard household bleach (5% sodium hypochlorite). Use a spray bottle to apply the IPA solution to a cloth to avoid over-saturating it.

Note

For more information about cleaning SMART accessories, see the SMART knowledge base article, [How to clean SMART Board surfaces and accessories](#).

Maintaining ventilation

The display requires proper ventilation. Dust buildup in the ventilation holes compromises cooling and can lead to product failure.

- Clean accessible ventilation holes monthly with a dry cloth.
- Use a vacuum cleaner with a narrow hose end fitting to clear the back ventilation holes regularly. You might have to remove the display from the wall.

For more information on removing the display, see *Removing and transporting the display* on the next page.

Caution

Avoid setting up or using the display in an area with excessive levels of dust, humidity, or smoke.

Preventing condensation

If the display has been moved from a cold environment to a warmer one (for example, from storage to the installation site), let the display sit for a few hours to allow it to acclimate to the new temperature. Failing to do so can cause humidity to build up in the space between the front glass and the LCD.

If condensation appears under the screen after you turn on the display, select an active video source and leave the display on for 48 hours. If the condensation doesn't dissipate, contact SMART Support if the display is still under warranty.

If there is enough moisture between the layers to cause the moisture to drip and run, remove power immediately and contact SMART Support if the display is still under warranty.

Replacing the pens and erasers

To prevent damage to the display's anti-glare coating, replace a pen if its nib or eraser pad become worn. You can purchase replacement pens and erasers from the Store for SMART Parts (see smarttech.com/support/parts-store).

Note

For pen and eraser part numbers, refer to the service parts diagrams.

Removing and transporting the display

On occasion, you might need to remove the display from its current wall mount and transport it to another location.

To remove the display safely, use two or more trained installers.

Warning

- Do not attempt to move the display by yourself. The display is very heavy.
- Do not move the display by connecting a rope or wire to the handles on the back. The display can fall and cause injury and product damage.

Important

Follow the documentation included with any third-party mounting hardware.

To remove the display

1. Turn off any connected computers.
2. Turn off the display (see *Turning off, turning on, and resetting the display* on page 45).
3. Flick the switch beside the AC power inlet to the OFF (O) position.
4. Remove all accessible cables and connectors.
5. Remove any modules from the accessory slot.
6. Lift the display from its mounting location.

Warning

Do not place the display on a sloping or unstable cart, stand or table. The display could fall, resulting in injury and severe product damage.

Caution

Do not leave the display face up, face down or upside down for an extended period. This could cause permanent damage to the screen.

7. Remove the mounting brackets.

To transport the display

See *Moving the display to the installation site* on page 20.

Updating system software

When an update to the system software or firmware is available, the display downloads the update in the background then waits for four hours of inactivity. When that happens, the display shows a two-minute countdown before the update begins. You can interrupt the countdown at any time. The display shows a blank screen for several minutes. When the update is complete, the iQ home screen, or input lobby appears.

Note

You can configure your organization's network to allow or prevent automatic system software and firmware updates (see [Connecting to a network](#)).

Applying an automatic system software update manually

If the display has downloaded the system software update but hasn't yet applied the update, you can start the update process manually from Settings.

To apply an automatic system software update manually

1. From the Home screen, tap **Settings** .
2. Scroll to **Software Update**.
3. Under *Check for Updates Now*, tap **Apply Update Now**.

The display turns off and then turns back on. The display then applies the update.

Updating system software manually

You can download system software updates at smarttech.com/downloads and update your display using a USB drive.

Note

Instructions for downloading and installing system software updates are provided on the software downloads page.

Chapter 5 Troubleshooting

The display isn't turning on	51
The display is turning on when it shouldn't	52
The screen is blank or there's a problem with the image on the screen	52
There's no sound or there's a problem with the sound	54
Touch isn't working as expected	55
The pens and erasers aren't working as expected	56
iQ apps aren't working as expected	57
The remote control isn't working as expected	57
SMART software on connected computers isn't working as expected	57
The SMART OPS PC module isn't working as expected	57
Contacting your reseller for additional support	58

This chapter explains how to resolve a variety of common issues with the display. If your specific issue isn't described here or the solutions to the symptoms don't work, refer to the SMART knowledge base for additional troubleshooting information.

community.smarttech.com/s/topic/0TOU0000000kAJ0OAM/interactive-displays?tabset-823c7=2



The display isn't turning on





Symptom	Troubleshooting steps
The power light isn't lit.	<ul style="list-style-type: none"> Make sure the power cable is securely fastened to the power outlet and the display. <p>Note</p> <p>If the power cable is connected to a power bar, make sure the power bar is securely fastened to the power outlet and turned on.</p> <ul style="list-style-type: none"> Make sure the switch beside the AC power inlet is in the ON (I) position. Make sure the power outlet is working by testing it with a different device. Make sure the power cable is working by testing it with a different device.
The power light is lit, but the screen is blank.	<ul style="list-style-type: none"> Press the Power button on the convenience panel or the remote control. Make sure the proximity sensors aren't blocked. Restart the display. See <i>Turning off, turning on, and resetting the display</i> on page 45. Determine if the problem is with the video. See <i>The screen is blank or there's a problem with the image on the screen</i> on the next page.

The display is turning on when it shouldn't

Symptom	Troubleshooting steps
The display turns on or enters Ready mode when it shouldn't.	<ul style="list-style-type: none"> • Check for and, if possible, move the display away from the following: <ul style="list-style-type: none"> ◦ Direct sunlight ◦ Bright lights ◦ Forced air ducts ◦ Plasma displays ◦ Infrared audio systems and other infrared sources ◦ Polished floors, glass walls, or other reflective surfaces • Be aware that the proximity sensors' range is 16' (5 m). <p>Note</p> <p>The display will turn on when one of its receptacles receives a video signal, when checking for or applying system updates, or when it receives commands via its RS-232 connection.</p>

The screen is blank or there's a problem with the image on the screen

Symptom	Troubleshooting steps
The screen is blank.	<ul style="list-style-type: none"> • Make sure the screen is working by tapping the Home button  below the screen or pressing the Home button  on the remote control to open the Home screen. • Make sure the display is not in Standby mode by pressing the Power button . • Make sure any connected computers are on and not in an energy saving mode. • Restart the display and any connected computers. See <i>Turning off, turning on, and resetting the display</i> on page 45. • Replace the video cables connecting any computers to the display to determine if the issue is with the cables.
A computer is connected to the display, but only a connection message appears on the screen.	<ul style="list-style-type: none"> • Make sure the computer is connected to the currently selected input. • Make sure the display supports the connected computer's refresh rate. See <i>Setting a connected computer's resolution and refresh rate</i> on page 35. • If the currently selected input is a computer, make sure the computer is not in an energy saving mode.

Symptom	Troubleshooting steps
<p>The image on the screen is distorted. OR There are lines, snow or, other visual noise on the screen. OR The image is flickering or flashing. OR The image is dim.</p>	<ul style="list-style-type: none"> • Tap the Home button  below the screen or press the Home button  on the remote control to open the Home screen. If it appears correctly, the issue is with the video input. • Switch to a different input and then back to the first input. • Make sure any connected computers are on and not in an energy savings mode. • Restart the display and any connected computers. <i>See Turning off, turning on, and resetting the display on page 45.</i> • Set any connected computers' resolution and refresh rate to values that the display supports. • Replace the video cables that connect any computers to the display to determine if the issue is with the cables. Make sure a replacement cable meets the required specifications. <i>See Using recommended cables on page 35.</i>
<p>(For SMART Board 6000S (V3) and 6000S (C) models) There is no image when using the USB Type-C receptacle with a computer</p>	<ul style="list-style-type: none"> • Make sure that the computer supports Display Port Alternate Mode video via USB Type-C. Look for the Display Port logo beside the USB Type-C receptacle on the computer. If it's not there, the computer may not support Display Port Alternate Mode video via USB Type-C. • Make sure the cable used with the USB Type-C receptacle supports Super Speed (5Gbps) USB. Look for the Super Speed USB logo on the cable. If the cable doesn't have the Super Speed USB logo, it may not have the internal wiring necessary to carry Display Port Alternate Mode video data.
<p>There are bright spots on the screen.</p>	<ul style="list-style-type: none"> • Tap the Home button  below the screen or press the Home button  on the remote control to open the Home screen. If it appears correctly, the issue is with the video input. • Take a photograph of the screen and send it to SMART support. If SMART support determines that the issue is with the screen and the display is under warranty, you may be eligible for a replacement.
<p>Colors don't appear correctly.</p>	<ul style="list-style-type: none"> • Be aware that if two or more displays are mounted side-by-side, there could be minor differences in colors across the displays. This issue is not unique to SMART products. • If the screen is completely lacking one color on the screen or the color problems occur on the Home screen, see <i>Contacting your reseller for additional support on page 58</i>. • If you're using a VGA video input, use a different cable or connect a different source to see if the issue is with the cable or input source. • Adjust the display's color settings, or reset them to the factory defaults. <i>See Appendix A Adjusting settings on page 59.</i>
<p>The image is cut off or shifted to the left or right.</p>	<ul style="list-style-type: none"> • Adjust any connected computers' video settings, particularly zoom, crop, and underscan. <i>See the computer's operating system documentation.</i> • If you're using a VGA video input and any connected computers' desktops are entirely black, change them to dark gray or a different color. • If any connected computers' desktops are extended across multiple screens, duplicate the desktops across the screens or set the display as the only screen.

Symptom	Troubleshooting steps
The image doesn't fill the entire screen.	<ul style="list-style-type: none"> Adjust any connected computers' video settings, particularly overscan. See the computer's operating system documentation. Make sure the connected computer's video connector is configured to output a supported video signal. See No video display output from a laptop.
A persistent image appears on the display.	See Image persistence or burn in on LCD displays .

There's no sound or there's a problem with the sound

Symptom	Troubleshooting steps
<p>There's no sound. OR There is sound, but the volume is low. OR The sound is distorted or muffled.</p>	<ul style="list-style-type: none"> If you're using an external audio system, make sure it is turned on. Make sure the cables connecting the display to the computer are securely fastened. <p>Notes</p> <ul style="list-style-type: none"> The display's stereo 3.5 mm in connector works with the VGA input only. Connecting an audio cable to the display's stereo 3.5 mm out connector disables the internal speakers. If you're using the display's S/PDIF out connector to connect a sound bar or receiver for external speakers, see Connecting an external audio system on page 38. <ul style="list-style-type: none"> If you're using the display's stereo 3.5 mm out connector, adjust the volume on the display and the connected computer and make sure neither are muted. If you're using the display's S/PDIF out connector, adjust the volume on the external audio system and make sure the audio system isn't muted. Adjust the display's audio settings. See Audio on page 67. If you're using the integrated speakers, set the volume for the computer and any running applications to 80%, and then adjust the display's volume. OR If you're using an external audio system, set the volume for the computer, any running applications and the display to 80%, and then adjust the external audio system's volume.
There is a whine or buzzing sound coming from the back of the display.	<ul style="list-style-type: none"> Be aware that these sounds are normal. All displays emit some electrical noise. Such sounds may be more noticeable with some displays than with others. However, if you hear noise from the front of the display, further investigation is required. Connect all devices to the same power outlet or power bar.
<p>For SMART Board (V3) models The microphone array is not picking up sound, and the green indicator light is not lit.</p>	<ul style="list-style-type: none"> Ensure that the microphone array is enabled in the Settings menu. If you're using an external computer, ensure that the computer's audio settings are configured to use the <i>SMART IFP Mic</i> as the input source.

Touch isn't working as expected

Symptom	Troubleshooting steps
<p>The display doesn't respond to touch.</p>	<ul style="list-style-type: none"> • For SMART Board 6000S (V3) models: The touch system might not have initialized correctly when the display started. Turn the display off, wait at least 30 seconds, and then turn the display back on. To turn the display off completely, flick the switch beside the AC power inlet to the OFF (O) position. <i>See Turning off, turning on, and resetting the display on page 45</i> • Make sure SMART Product Drivers are installed and running on connected computers. (SMART Board 6000S (V3) models displays require SMART Product Drivers 12.18 or later, and SMART Board 6000S (C) and 6000S model displays require SMART Product Drivers 12.14 or later). • Make sure the USB cable between the display and the computer doesn't exceed the supported maximum cable length. See Using recommended cables on page 35. • If a connected computer reports "Too many USB hubs" or "cannot start (code 10)", see the knowledge base article, SMART Board interactive displays and USB tier structure use. • Make sure any connected computers have detected the display's USB connection. • On Windows computers, open Device Manager and make sure there is no red X or yellow explanation mark (!) over the display's icon. • On Mac computers, open System Information and make sure there are no error messages in the display's row. • For Mac computers with macOS Mojave, see How to resolve issues with installing and using SMART Learning Suite software on macOS Mojave.
<p>The display responds to touch intermittently. OR When you touch the screen, the pointer doesn't appear in the correct place.</p>	<ul style="list-style-type: none"> • Restart the display. <i>See Turning off, turning on, and resetting the display on page 45.</i> • Make sure SMART Product Drivers and SMART Ink are installed and running on any connected computers. • Confirm with the installers that the computer is connected to the display with only a single cable. • Remove infrared sources, such as incandescent or arc lights, desk lamps, and infrared audio devices, or move the display to another location in the room. • Remove any USB extenders to help isolate the USB cable. • Update the firmware.

The pens and erasers aren't working as expected

Symptom	Troubleshooting steps
<p>The display doesn't respond to touch or writing with a pen.</p>	<ul style="list-style-type: none"> • Make sure SMART Product Drivers are installed and running on connected computers. (SMART Board 6000S (V3) models displays require SMART Product Drivers 12.18 or later, and SMART Board 6000S (C) and 6000S model displays require SMART Product Drivers 12.14 or later). • Make sure any connected computers have detected the display's USB connection. • On Windows computers, open Device Manager and make sure there is no red X or yellow explanation mark (!) over the display's icon. • On Mac computers, open System Information and make sure there are no error messages in the display's row. • Reinstall or update SMART Product Drivers and SMART Ink on any connected computers.
<p>The display responds to touch but not to writing with a pen.</p>	<ul style="list-style-type: none"> • Reinstall or update SMART Product Drivers and SMART Ink on any connected computers. <p>Note</p> <p>Some Tool Explorer pens and tools may work only in the iQ system's whiteboard, not on input from an external computer.</p>
<p>When you write on the screen, the ink appears in the wrong place. OR Writing is intermittent. OR Ink disappears as you write. OR Ink colors change unexpectedly.</p>	<ul style="list-style-type: none"> • Restart the display. <i>See Turning off, turning on, and resetting the display on page 45.</i> • Confirm with the installers that the computer is connected to the display with only a single cable. • Clean the screen. <i>See Cleaning the screen on page 46.</i> • If the ink appears in the wrong place on input from a connected computer, use the <i>Orient</i> function in the SMART Settings app to orient the display's touch system to the connected computer. • Make sure SMART Product Drivers and SMART Ink are installed and running on any connected computers. • Use a known working pen from another display to check if the issue is being caused by the pen. • Remove infrared sources, such as incandescent or arc lights, desk lamps, and infrared audio devices, or move the display to another location in the room. • Update the firmware.
<p>You change the width or color of a pen's digital ink, but the width and color revert to the pen's defaults when you next pick up the pen from its holder on the display.</p>	<p>Be aware that a pen's color and thickness revert to the pen's default values when you place the pen back in its holder.</p>
<p>You can't write or draw in Microsoft® Office.</p>	<ul style="list-style-type: none"> • Make sure Microsoft Office 2013 or later is installed. • Reinstall or update SMART Product Drivers and SMART Ink.

iQ apps aren't working as expected

Symptom	Troubleshooting steps
iQ apps aren't working as expected.	See Troubleshooting the iQ experience .

The remote control isn't working as expected

Symptom	Troubleshooting steps
The display stops responding intermittently to the remote control.	See the SMART Knowledge Base article <i>The infrared (IR) sensor can stop responding intermittently to the remote control on SMART Board 6000S and 6000S Pro series displays</i> (smarttech.com/kb/171847).

SMART software on connected computers isn't working as expected

Symptom	Troubleshooting steps
SMART Notebook software isn't working as expected.	See Troubleshooting SMART Notebook .
Lumio by SMART isn't working as expected.	See Troubleshooting common issues in Lumio by SMART .
SMART TeamWorks software isn't working as expected.	See Troubleshooting SMART TeamWorks 4 Room .
SMART Meeting Pro software isn't working as expected.	See Basic troubleshooting for SMART Meeting Pro .
SMART Ink isn't working as expected.	See Troubleshooting SMART Ink .
SMART Product Drivers isn't working as expected.	See Troubleshooting SMART Product Drivers .

The SMART OPS PC module isn't working as expected

Symptom	Troubleshooting steps
The SMART OPS PC module isn't working as expected.	See the <i>SMART OPS PC modules user guide</i> (smarttech.com/kb/171747).

Contacting your reseller for additional support

If an issue you're experiencing with the display persists or isn't covered in this chapter or the knowledge base, contact your authorized SMART reseller (smarttech.com/where) for support.

Your reseller might ask you for the serial number for the display. The serial number is on a label located on the left side of the display (pictured).

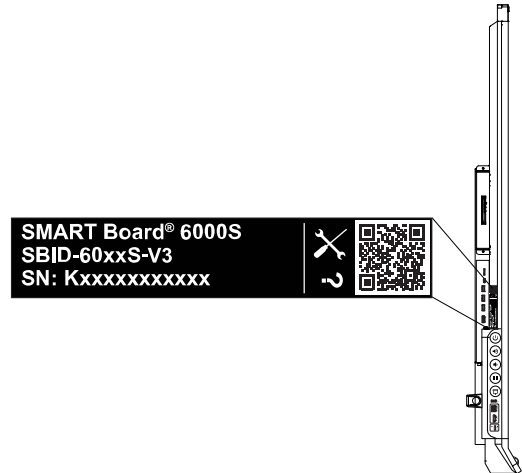

Tips

- Scan the QR code on the label to view the SMART Board 6000S or 6000S Pro series interactive display support pages on the SMART website.
- The label features the display's base model number (for example, SBID-6065-V3). Please note this number is different from the actual model/SKU number (for example SBID-6265-V3).
- You can also find the serial number in the iQ settings (see *Serial Number* on page 72).

Appendix A Adjusting settings

Network settings	59
Personalization	60
Application settings	61
System settings	64

You can access settings using the  icon on the Home screen.

Notes

- Settings can apply to a user or to the entire system. User-level settings change depending on the user who is signed in. System-level settings apply to all users. See the settings for more information.
- Some settings aren't available while you're signed in to your SMART Account. Sign out of your SMART Account on the display to see all settings.

Network settings

Option	Values	Function	Notes	User or system setting
▶ Wi-Fi				
• Wi-Fi	On Off	Enables or disables Wi-Fi on the display.	Turn on Wi-Fi to discover networks.	System
• [Wi-Fi network name]	[N/A]	Shows information about the connected wireless network.	[N/A]	System
• Wi-Fi MAC address	[N/A]	Shows MAC address for the network the display is connected to.	[N/A]	System
• Wi-Fi IP address	[N/A]	Shows IP address for the network the display is connected to.	[N/A]	System
▶ SMART iQ Ethernet				
• Advanced options	[N/A]	Options available when an Ethernet cable is connected	[N/A]	System

Option	Values	Function	Notes	User or system setting
<ul style="list-style-type: none"> Static IP (Use DHCP) 	On Off	Enables or disables DHCP to assign the display an IP address.	[N/A]	User
<ul style="list-style-type: none"> Proxy (Use proxy) 	On Off	Enables or disables a proxy server for connecting to the network.	[N/A]	User
<ul style="list-style-type: none"> Proxy (Auto-configure) 	On Off	Enables or disables automatic configuration of the proxy server for connecting to the network.	[N/A]	User
<ul style="list-style-type: none"> MAC Address 	[N/A]	Shows information about the network the display is connected to.	[N/A]	System
<ul style="list-style-type: none"> IP Address 	[N/A]	Shows information about the network the display is connected to.	[N/A]	System
▶ Bluetooth				
<ul style="list-style-type: none"> Bluetooth 	On Off	Enable or disable the display's Bluetooth.	Turn on Bluetooth to view available Bluetooth devices.	System
<ul style="list-style-type: none"> View available bluetooth devices 	[N/A]	Shows available Bluetooth devices.	Turn on Bluetooth to view available Bluetooth devices.	System
▶ SMART Cloud				
<ul style="list-style-type: none"> Service Region 	[N/A]	Shows the service region.	[N/A]	System

Personalization

Note

If iQ is disabled, Personalization settings are not available.

Option	Values	Function	Notes	User or system setting
<ul style="list-style-type: none"> Wallpaper 	[Wallpapers]	Select the wallpaper that appears in the background.	1920 × 1080 images work best The display supports .png and .jpg file formats See Changing the display's wallpaper .	User

Application settings

Note

If iQ is disabled, Application settings are not available.

Option	Values	Function	Notes	User or system setting
▶ Launcher				
• Browser	On Off	Enables or disables Browser in the Apps Library.	[N/A]	User
• Screen Share	On Off	Enables or disables Screen Share in the Apps Library.	[N/A]	User
▶ Files Library				
• Whiteboard Storage	[N/A]	[N/A]	[N/A]	User
• Default Whiteboard Location	My Files > Lumio My Files > Board Files	Sets where new whiteboard files are saved when you're signed in to your SMART Account.	See Syncing SMART Notebook and Lumio files to the iQ experience.	User
• Files Storage	[N/A]	[N/A]	These options are not available for SMART Board 6000S (V3)	User
• Allow Google Drive integration in Files Library	On Off	Enables or disables access to Google Drive when you're signed in to your SMART Account.	See Opening your Google Drive or OneDrive on the display.	User
• Allow OneDrive integration in Files Library	On Off	Enables or disables access to OneDrive when you're signed in to your SMART Account.	See Opening your Google Drive or OneDrive on the display.	User
▶ SMART Whiteboard				
• Whiteboard Storage				
• Allow saving	On Off	Enables or disables saving SMART Whiteboard sessions.	[N/A]	System
• Whiteboard deletion policy	Delete after 1 week Delete after 1 Month Delete manually	Sets how SMART Whiteboards are saved.	[N/A]	System

Option	Values	Function	Notes	User or system setting
▶ SMART kapp Mobile App				
These options are not available for SMART Board 6000S (V3) or MX-V3 models				
<ul style="list-style-type: none"> Saving Whiteboards 	On Off	Enables or disables the Capture function in the SMART kapp app.	If this option is off, the QR code is not visible. The SMART kapp app cannot connect to the display and your mobile device cannot save snapshots of the display in the app.	User
<ul style="list-style-type: none"> Sharing Whiteboards 	On Off	Enables or disables the Invite function on the SMART kapp app.	If this option is off, you cannot invite people to your session.	User
• Annotation				
<ul style="list-style-type: none"> Enable annotation layers 	On Off	Enables or disables annotations on the Home screen, video input, and most apps.	[N/A]	User
• Other				
<ul style="list-style-type: none"> Enable Finger Inking 	On Off	When enabled, you can write with your finger. Default is off.	[N/A]	User
<ul style="list-style-type: none"> Enabled Shared Whiteboard 	On Off	When enabled, you can share the whiteboard with student devices.	[N/A]	User
▶ Screen Share				
These options are not available for SMART Board 6000S (V3) or MX-V3 models				
<ul style="list-style-type: none"> Default Screen Share App 	SMART Screen Share SMART Mirror	Sets default screen share app to be used when you select Screen Share from the main screen.	SMART Screen Share is selected by default.	System
<ul style="list-style-type: none"> Require Permission 	On Off	Enables or disables automatic connection from a device sharing its screen.	[N/A]	System
<ul style="list-style-type: none"> AirPlay 	On Off	Enables or disables the AirPlay protocol.	AirPlay is enabled by default.	System
<ul style="list-style-type: none"> Google Cast 	On Off	Enables or disables the Google Cast protocol.	Google Cast is enabled by default.	System

Option	Values	Function	Notes	User or system setting
<ul style="list-style-type: none"> Miracast 	On Off	Enables or disables the Miracast protocol.	<p>Miracast is enabled by default.</p> <p>ⓘ Important Devices that use AirPlay and Google Cast can't connect to the display while a Miracast device is connected.</p>	System
<ul style="list-style-type: none"> Performance Logging 	On Off	SMART Support may ask users to enable Performance Logging to help diagnose issues.	Performance Logging is disabled by default.	System
<ul style="list-style-type: none"> Auto-disconnect from Wifi for Miracast 	On Off	When enabled, the display disconnects from the network when a device shares its screen using Miracast.	<p>SMART recommends enabling this setting for areas with high network saturation or busy networks.</p> <p>ⓘ Important Only one device can connect to the display when Miracast is enabled. This setting used to be named "Miracast Connection Handling"</p>	System
<ul style="list-style-type: none"> Reset Screen Share 	[N/A]	Closes and restarts the Screen Share app and its discovery services.	You can restart Screen Share as a troubleshooting step if a mobile device or computer can't find or connect to the display.	System
<ul style="list-style-type: none"> Use Web Player 	On Off	When enabled, the display uses a different method to stream videos.	If this method doesn't work, disable it to return to the original method.	System
▶ Notifications				
<ul style="list-style-type: none"> Do not disturb 	On Off	When enabled, the display doesn't show notifications for any app.	[N/A]	System
<ul style="list-style-type: none"> [Apps] 	On Off	When enabled, the display shows notifications for apps.	[N/A]	User
▶ Installed Apps				
<ul style="list-style-type: none"> Allow App Store 	On Off	When enabled, the App Store is available and the display can download and install new apps.	[N/A]	User

System settings

Option	Values	Function	Notes	User or system setting
▶ System				
<ul style="list-style-type: none"> Access to USB mass storage devices 	On Off	Enables or disables access to a USB drive.	[N/A]	System
<ul style="list-style-type: none"> Advanced Options 				
<ul style="list-style-type: none"> SMART Board with iQ 	On Off	Enables or disables the iQ experience.	[N/A]	System
<ul style="list-style-type: none"> Default input 	Inputs available on the display.	Select the default input the display will use when starting.	The iQ embedded experience is the default input.	System
<ul style="list-style-type: none"> Home Button Brightness 	High Medium Low	Sets the brightness of the Home button LED.	Default is Low. This option is not available for SMART Board 6000S (V3) models.	System
<ul style="list-style-type: none"> Home Button Activation Interval 	80 milliseconds 180 milliseconds 280 milliseconds 560 milliseconds 1120 milliseconds 2080 milliseconds	Sets the sensitivity of the Home button.	Default is 80 milliseconds.	System
<ul style="list-style-type: none"> Home Button Mode 	Use physical button to go home (Default)	Sets the behavior of the Home button.	Default is Low. This option is not available for SMART Board 6000S (V3) models.	System
▶ Power				
<ul style="list-style-type: none"> Turn on when people are nearby 	On Off	Sets the display to turn on if the presence detection sensors detects users in the room.	This option is off by default.	System

Option	Values	Function	Notes	User or system setting
<ul style="list-style-type: none"> Turn screen off after 	Disabled 1 min 5 mins 30 mins 1 hour 1.5 hours 2 hours 5 hours 10 hours	Sets the number of minutes of inactivity before the display goes in to an energy saving mode.	The default is 60 minutes.	System
<ul style="list-style-type: none"> Energy Saver 				
<ul style="list-style-type: none"> Go to energy saving mode after 	Disabled 1 min 5 mins 30 mins 1 hour 1.5 hours 2 hours 5 hours 10 hours	Sets the number of minutes of inactivity before the display enters an energy saving mode.	The default is 60 minutes.	System
<ul style="list-style-type: none"> Standby (Shutdown) 	[N/A]	If selected, the display will turn off all running components to achieve maximum energy savings but wakes up slower.	This option is more energy efficient. This option is the default for displays in the EU. For information about the display's energy saving modes, see <i>About energy saving modes</i> on page 30.	System

Option	Values	Function	Notes	User or system setting
<ul style="list-style-type: none"> Networked Standby (Sleep) 	[N/A]	If selected, the display wakes up faster and can be turned on up by a Wake on LAN command from the network.	<p>This option is less energy efficient.</p> <p>This option is the default for displays not in the EU.</p> <p>For information about the display's energy saving modes, see <i>About energy saving modes</i> on page 30.</p>	System
<ul style="list-style-type: none"> External Inputs 				
<ul style="list-style-type: none"> Apply power settings even when displaying an external video source 	On Off	If enabled, the display will enter an energy saving mode even when an external video input is connected.	[N/A]	System
► Display				
<ul style="list-style-type: none"> Screen Adjustment 				
<ul style="list-style-type: none"> Brightness 	0–100	Sets the overall brightness of the image.	[N/A]	System
<ul style="list-style-type: none"> Advanced Display Options 				
<ul style="list-style-type: none"> Color Temperature 	Very Cool Cool Neutral Warm Very Warm	Sets how colors appear on the display.	[N/A]	System
<ul style="list-style-type: none"> Lightness 	0–488	Sets the overall lightness of the image.	<p>[N/A]</p> <p>This option is not available for SMART Board 6000S (V3) models.</p>	System
<ul style="list-style-type: none"> Contrast 	0–488	Sets the overall contrast of the image.	<p>[N/A]</p> <p>This option is not available for SMART Board 6000S (V3) models.</p>	System
<ul style="list-style-type: none"> Saturation 	0–511	Sets the overall saturation of the image.	<p>[N/A]</p> <p>This option is not available for SMART Board 6000S (V3) models.</p>	System

Option	Values	Function	Notes	User or system setting
• Red	0–448	Sets the overall red of the image..	[N/A]	System
• Green	0–448	Sets the overall green of the image.	[N/A]	System
• Blue	0–448	Sets the overall blue of the image.	[N/A]	System
• HDMI Output				
• Default resolution	Auto 4K60 1080p60 720p60 640x480p60	Sets the HDMI out resolution.	[N/A] The HDMI output may not be visible for several seconds when you change the output resolution on 6000S (V3) models.	System
• HDMI Input				
• Advanced HDMI Settings	HDMI 1.0 HDMI 2.0 HDMI 3.0 OPS VGA	Sets the HDMI version, HDP pulse width, and MHL setup delay for each HDMI input.	You can also enable or disable strictly conformant HDMI Input DDC SDA timing and forbid or allow HDCP 2.2 with older receivers.	System
• Go to the Input Lobby when there is no signal	On Off	When enabled, show the input previews when there is no signal.	[N/A]	System
▶ Audio				
• Audio In				
These options are available for SMART Board 6000S (V3) models only.				
• Volume	Range slider	Sets the microphone’s volume.	[N/A]	System
• Built-in microphone	On Off	Enables or disables the display’s built-in microphone. The default is on.	[N/A]	System
• Noise suppression	On Off	Enables or disables the noise suppression filter for the display’s built-in microphone. The default is on.	Enable the noise suppression filter to reduce background noise when using the display’s built-in microphone.	System
• Audio Out				
• Volume	Range slider	Sets the volume from the speakers	[N/A]	System

Option	Values	Function	Notes	User or system setting
<ul style="list-style-type: none"> Built-in Speakers 	On Off	Enables or disables the display's internal speakers.	When analog speakers are connected to the display, the display's internal speakers are disabled automatically.	System
<ul style="list-style-type: none"> Audio Properties 				
<ul style="list-style-type: none"> Balance 	Range slider	Sets the audio output from the speakers.	Drag the slider all the way to the left to have all audio from the left speaker. Drag the slider all the way to the right to have all the audio from the right speaker.	System
<ul style="list-style-type: none"> Bass 	Range slider	Sets the bass level.	[N/A]	System
<ul style="list-style-type: none"> Treble 	Range slider	Sets the treble level.	[N/A]	System
<ul style="list-style-type: none"> ▶ Date & Time 				
<ul style="list-style-type: none"> Automatic Date & Time 	On Off	Sets the display's date and time automatically.	Configure the network to allow Network Time Protocol (NTP) requests to internet time servers. See Connecting to a network .	System
<ul style="list-style-type: none"> Date 	[N/A]	Sets the display's date.	Disable Automatic date & time to set the date manually.	System
<ul style="list-style-type: none"> Time 	[N/A]	Sets the display's time.	Disable Automatic date & time to set the time manually.	System
<ul style="list-style-type: none"> 24 Hour Time 	On Off	Shows the display's time using the 24-hour clock.	[N/A]	User
<ul style="list-style-type: none"> Time Zone 	[N/A]	Sets the display's time zone.	[N/A]	System
<ul style="list-style-type: none"> ▶ Language 				
<ul style="list-style-type: none"> System Language 	[Languages]	Sets the language for the settings menu.	[N/A]	User

Option	Values	Function	Notes	User or system setting
<ul style="list-style-type: none"> Ink-To-Text Language 	[Languages]	Sets the language for converting writing to text.	You can install and uninstall languages. See Configuring ink-to-text languages for the Text pen.	User
<ul style="list-style-type: none"> Country 	[Countries]	Sets the display's country.	[N/A]	System
▶ Diagnostics				
<ul style="list-style-type: none"> Factory Reset 	[N/A]	Resets all options to their default values.	Only administrators should reset the display.	[N/A]
<ul style="list-style-type: none"> Save Log File to a USB key 	[N/A]	Copy diagnostic logs to a USB drive.	[N/A]	[N/A]
<ul style="list-style-type: none"> Submit Log file to SMART 	[N/A]	Send diagnostic logs to SMART.	[N/A]	[N/A]
<ul style="list-style-type: none"> Improve the Experience 	On Off	Sends usage statistics and error reports to SMART.	[N/A]	User
<ul style="list-style-type: none"> Support ID 	[Support ID]	Shows the support ID associated with the display.	Enable this option only on the advice of SMART Support, and only in combination with the board's Support ID.	[N/A]
<ul style="list-style-type: none"> Logging Service 	[Languages]	Sets the language for the settings menu.	[N/A]	User
<ul style="list-style-type: none"> Enable Logging Service 	On Off	Enables or disables saving logs to a USB drive	This option allows the temporary iQ system log files to survive a system restart, at the cost of some device storage space.	System
<ul style="list-style-type: none"> Log Levels 	[N/A]	[N/A]	[N/A]	[N/A]
<ul style="list-style-type: none"> Log Level RAW 	On Off	Advanced logging options to be set under the direction of SMART Support	[N/A]	System
<ul style="list-style-type: none"> Log Level SPM 	On Off	Advanced logging options to be set under the direction of SMART Support	[N/A]	System

Option	Values	Function	Notes	User or system setting
<ul style="list-style-type: none"> Log Level RATP 	On Off	Advanced logging options to be set under the direction of SMART Support	[N/A]	System
<ul style="list-style-type: none"> Log Level SEP 	On Off	Advanced logging options to be set under the direction of SMART Support	[N/A]	System
<ul style="list-style-type: none"> Log Level EXT 	On Off	Advanced logging options to be set under the direction of SMART Support	[N/A]	System
► Security				
<ul style="list-style-type: none"> Lock Down Settings 	[N/A]	Lock down the display's settings using a security certificate on a USB drive.	See Locking down the Settings app for more information.	System
<ul style="list-style-type: none"> Make passwords visible 	On Off	Reveals characters when typing a password in an app or website	[N/A]	System
<ul style="list-style-type: none"> Install certificates 	[N/A]	Install security certificates to connect to a network.	[N/A]	System
<ul style="list-style-type: none"> View certificates 	[N/A]	View installed security certificates.	[N/A]	System
<ul style="list-style-type: none"> View root CA certificates 	[N/A]	[N/A]	[N/A]	System
<ul style="list-style-type: none"> Automatic inactivity log out 	Disabled 1 hour 8 hours 12 hours	Automatically logs a user off after a time of inactivity.	[N/A]	System
<ul style="list-style-type: none"> Enable automatic login 	On Off	Automatically logs in a user if enabled	Default is off.	System
<ul style="list-style-type: none"> Clean up 				
<ul style="list-style-type: none"> Clean Up Policy 	Disabled Manually reset with the Clean Up button in the launcher 1 hour 2 hours 3 hours 1 day	Sets how often the display cleans up.	[N/A]	System
<ul style="list-style-type: none"> Clean Up the browser 	[N/A]	Closes the browser tabs and clears the history, cache, and cookies.	[N/A]	System
<ul style="list-style-type: none"> Clean up app data and preferences 	[N/A]	Closes open applications and clears app data and preferences.	[N/A]	System

Option	Values	Function	Notes	User or system setting
▶ Software Update				
<ul style="list-style-type: none"> Updates Channel 	Stable Channel Beta Channel	Sets which iQ system software updates the display receives.	When switching from the Beta channel to the Stable channel, a factory reset occurs. See page 69 for more information about factory reset. For more information about the Beta Channel, see Switching to the Beta channel .	System
<ul style="list-style-type: none"> Check for Updates Now 	[N/A]	Checks for updates to the system software.	If an update is available, the text changes to Apply update now. The display must be connected to the internet to check for system software updates or a USB drive with the system software update file is connected to the display.	[N/A]
▶ Remote Management				
<ul style="list-style-type: none"> Launch Remote Management Settings 	[N/A]	Configure the display's connection settings with the Radix Viso server.	This option is only enabled when Remote Management is enabled.	System
<ul style="list-style-type: none"> Remote Management Enabled 	On Off	Enables or disables Remote Management on the display.	[N/A]	System
<ul style="list-style-type: none"> Radix Viso version 	[N/A]	Shows the Radix Viso version.	[N/A]	System
▶ About				
<ul style="list-style-type: none"> Board Name 	[N/A]	Select a name for your display.	[N/A]	System
<ul style="list-style-type: none"> Help 	[N/A]	Shows the SMART support site for iQ.	[N/A]	[N/A]

Option	Values	Function	Notes	User or system setting
• Send Feedback	[N/A]	Send feature request to SMART.	[N/A]	[N/A]
• Board Details	[N/A]	[N/A]	[N/A]	[N/A]
• Build Number	[N/A]	Shows the iQ system software's version number.	[N/A]	[N/A]
• Serial Number	[N/A]	Shows the display's serial number.	[N/A]	[N/A]
• Part Number	[N/A]	Shows the display's part number.	[N/A]	[N/A]
• Model Number	[N/A]	Shows the display's base model number. Displays purchased as 62xxS or 64xxS SKUs have a 60xxS base model number.	[N/A]	[N/A]
• Configuration	EDU-iQ (Education iQ experience) ENT-iQ (Enterprise iQ experience) ENT-NoiQ (Enterprise, display-only configuration without iQ)	Shows the display's iQ system configuration.	[N/A]	[N/A]
• Firmware Details	[N/A]	[N/A]	[N/A]	[N/A]
• Touch controller firmware version	[N/A]	Shows the display's touch controller firmware version.	[N/A]	[N/A]
• Scaler version	[N/A]	Shows the display's scaler version. This option is not available for the SMART Board 6000S (V3), 6000S (C), and 6000S models.	[N/A]	[N/A]
• Pen firmware version	[N/A]	Shows the display's pen detection system firmware version.	[N/A]	[N/A]
• Legal Information	[N/A]	[N/A]	[N/A]	[N/A]
• End User License Agreement	[N/A]	Shows the SMART end user license agreement.	[N/A]	[N/A]
• Open Source Licenses	[N/A]	Shows the open source licenses.	[N/A]	[N/A]
• SMART Intellectual Property	[N/A]	Shows the SMART intellectual property information.	[N/A]	[N/A]

Appendix B Enrolling the display in SMART Remote Management

Your SMART Board 6000S or 6000S Pro series interactive display has a built-in feature that enables you to enroll the display with your organization's SMART Remote Management account. When you enroll one of these displays, you can use SMART Remote Management to centrally control features and settings for the display, such as:

- blocklists and allowlists
- Wi-Fi
- wallpaper
- certificates
- lock screen
- available apps

To learn how to enroll your display, see [Enrolling a SMART Board interactive display in SMART Remote Management](#).

Appendix C Managing the SMART Board 6000S (V3) display using RS-232

Configuring the computer's serial interface settings	75
Commands and responses	76
Power state commands	77
Input commands	79
Brightness commands	79
Freeze commands	79
Screen shade commands	80
Volume commands	80
Mute commands	80
Firmware version commands	80
Serial number commands	81
Part number commands	81
Model number commands	81
Resolving issues with managing the display using RS-232	81

You can connect an RS-232 cable from a computer's serial output to the display's RS-232 in connector to remotely select video inputs, turn the display on or off, and get information about the display's current settings, such as volume and power state.

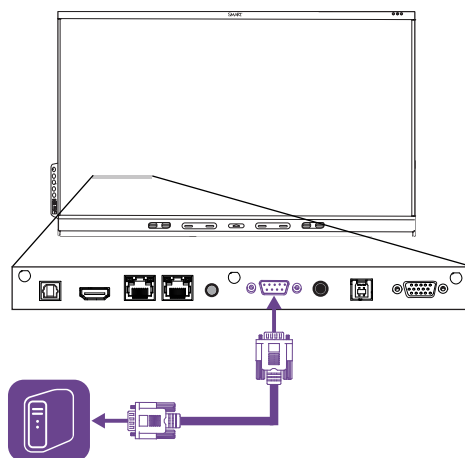

! **Important**

Use only a standard RS-232 cable. Do not use a null modem cable. Null modem cables typically have ends of the same type.

Tip

SMART also offers SMART Remote Management cloud-based device-management software, which you can use to manage SMART Board interactive displays with iQ and devices running Windows, Chrome™ OS, Android™, and iOS operating systems. For more information, see [SMART Remote Management](#).

Configuring the computer's serial interface settings

Configure the computer's serial interface before sending commands to the display.

To configure the computer's serial interface

1. Turn on the display.
2. Turn on the computer, and then start the serial communications program or terminal emulation program.
3. Activate local echo.
4. Configure the serial interface settings using the following values, and then press ENTER.

Baud rate	19200
Data length	8
Parity bit	None
Stop bit	1

A command prompt (>) appears on the following line, and the display can now accept commands from the computer.

Note

If no message appears or an error message appears, the serial interface isn't configured correctly. Repeat steps 3 and 4.

Commands and responses

To access display information or to adjust display settings using the room control system, type commands after the command prompt (>) and wait for the response from the display.

Correct

```
>get volume  
volume=55  
>
```

In the example below, the user used `--50` instead of `-50`.

Incorrect

```
>set volume=-50  
invalid cmd: setvolume=-50  
>
```

Notes

- Use ASCII formatted commands.
- Commands aren't case-sensitive and extra spacing is ignored.
- In many terminal applications on a computer, you can use the BACKSPACE key when typing commands.
- Review each entry carefully before sending a command to the display.
- Don't send another command until you receive the response and the next command prompt (>). If no command prompt is present, send a carriage return character (<CR>) to the display. If the display is ready to receive commands, it will show a command prompt after receiving the carriage return.

To retrieve a setting's current value

Use a `get` command.

This example shows how to get the volume:

```
>get volume  
volume=55  
>
```

To assign a value to a setting

Use a `set` command.

This example sets the volume to 65:

```
>set volume=65
volume=65
>
```

To increase or decrease the value of a setting

Use the `set` command to increase or decrease the value by a designated number.

This example increases the volume by 5:

```
>set volume+5
volume=70
>
```



This example decreases the volume by 15:

```
>set volume-15
volume=55
>
```

Power state commands

Get command	Set command	Response
get powerstate	<p>set powerstate[Value] Where [Value] is one of the following:</p> <ul style="list-style-type: none"> • =on • =ready • =standby • =powersave <p>Notes</p> <ul style="list-style-type: none"> • If the display is in UPDATEON or UPDATEREADY state, it might not change power states after receiving the command. • When switching between power states on displays running iQ 3.11 or earlier, wait at least 30 seconds before sending another command. 	<p>powerstate=[Value] Where [Value] is one of the following:</p> <ul style="list-style-type: none"> • on • ready • standby • powersave • updateon • updateready

The display has six power states:

Power state	Description
ON	The display is in normal operating mode.
READY	<p>The screen is off, but the display is ready to turn on when one of the following occurs:</p> <ul style="list-style-type: none"> • A user presses the Power button  on the convenience panel or the remote control. • A user picks up a pen or the eraser. • The display receives the <code>set powerstate=on</code> command. • The proximity sensors detect people in the room. • The display receives a video signal.
STANDBY	<p>The screen is off, and the display is in a low power state. The display enters READY or ON state when one of the following occurs:</p> <ul style="list-style-type: none"> • The proximity sensors detect people in the room. • A user presses the Power button  on the convenience panel or the remote control. • The display receives <code>set powerstate=ready</code> or <code>set powerstate=on</code> command. <p>This power state is the default energy saving mode for displays set to a non-EU location.</p> <p>Note The EU uses “networked standby” to describe this power state.</p>
POWERSAVE	<p>The screen is off, and the display is a very low power state. The display enters READY or ON state when one of the following occurs:</p> <ul style="list-style-type: none"> • A user presses the Power button  on the convenience panel or the remote control. • The display receives <code>set powerstate=ready</code> or <code>set powerstate=on</code> command. <p>This power state is the default energy saving mode for displays set to an EU location.</p> <p>Note The EU uses “standby” to describe this power state.</p>
UPDATEON	The display is updating firmware. Do not turn off the display.
UPDATEREADY	The display is updating firmware while the screen is off. Do not turn off the display.

With the exception of `get powerstate` and `set powerstate`, commands are available only when the display is in READY or ON power state.

Input commands

Get command	Set command	Response
If one display is connected		
<code>get input</code>	<code>set input[Value]</code> Where [Value] is one of the following: <ul style="list-style-type: none"> • =hdmi1 • =hdmi2 • =hdmi3 • =vga1 • =ops1 • =usbc1 • =usbc2 • =android 	<code>input=[Value]</code> Where [Value] is one of the following: <ul style="list-style-type: none"> • hdmi1 • hdmi2 • hdmi3 • vga1 • ops1 • usbc1 • usbc2 • android • none

Brightness commands

Get command	Set command	Response
<code>get brightness</code>	<code>set brightness[Value]</code> Where [Value] is one of the following: <ul style="list-style-type: none"> • +[Value] • -[Value] • =[0-100] 	<code>brightness=[Value]</code> Where [Value] is a number between 0 and 100

Freeze commands

Get command	Set command	Response
<code>get videofreeze</code>	<code>set videofreeze[Value]</code> Where [Value] is one of the following: <ul style="list-style-type: none"> • =on • =off 	<code>videofreeze=[Value]</code> Where [Value] is one of the following: <ul style="list-style-type: none"> • on • off

Screen shade commands

Get command	Set command	Response
get screenshade	set screenshade[Value] Where [Value] is one of the following: <ul style="list-style-type: none"> • =on • =off 	screenshade=[Value] Where [Value] is one of the following: <ul style="list-style-type: none"> • on • off

Volume commands

Get command	Set command	Response
get volume	set volume[Value] Where [Value] is one of the following: <ul style="list-style-type: none"> • +[Value] • -[Value] • =[0-100] <p>Note</p> <ul style="list-style-type: none"> • If the display's audio is muted, changing the volume also unmutes the audio. • Setting the volume to zero also mutes the volume. 	volume=[Value] Where [Value] is a number between 0 and 100

Mute commands

Get command	Set command	Response
get mute	set mute[Value] Where [Value] is one of the following: <ul style="list-style-type: none"> • =on • =off 	mute=[Value] Where [Value] is one of the following: <ul style="list-style-type: none"> • on • off

Firmware version commands

Get command	Response
get fwversion	fwversion=[Value] Where [Value] is the firmware version.

Serial number commands

Get command	Response
get serialnum	serialnum=[Value] Where [Value] is the serial number.

Part number commands

Get command	Response
get partnum	partnum=[Value] Where [Value] is the part number, including the revision.

Model number commands

Get command	Response
get modelnum	modelnum=[Value] Where [Value] is the model number of the display.

Resolving issues with managing the display using RS-232

The following table presents common issues with managing the display using RS-232 and explains how to resolve them:

Symptom	Troubleshooting steps
Managing the display using RS-232 isn't working as expected.	<ul style="list-style-type: none"> • Make sure all the cable connections are secure. • Restart the display and the remote management system. See <i>Turning off, turning on, and resetting the display</i> on page 45. • Configure the serial interface settings in your RS-232 terminal application. See <i>Configuring the computer's serial interface settings</i> on page 84.
You're experiencing other issues with managing the display using RS-232, or the previous steps don't resolve the issue.	See <i>Chapter 5 Troubleshooting</i> on page 51.

Appendix D Managing SMART Board 6000S (C) or 6000S series displays using RS-232

Connecting multiple displays	83
Configuring the computer's serial interface settings	84
Commands and responses	84
Power state commands	87
Input commands	89
Brightness commands	89
Freeze commands	90
Screen shade commands	90
Volume commands	90
Mute commands	90
Firmware version commands	91
Serial number commands	91
Part number commands	91
Resolving issues with managing the display using RS-232	92

You can connect an RS-232 cable from a computer's serial output to the display's RS-232 in connector to remotely select video inputs, turn the display on or off, and get information about the display's current settings, such as volume and power state.

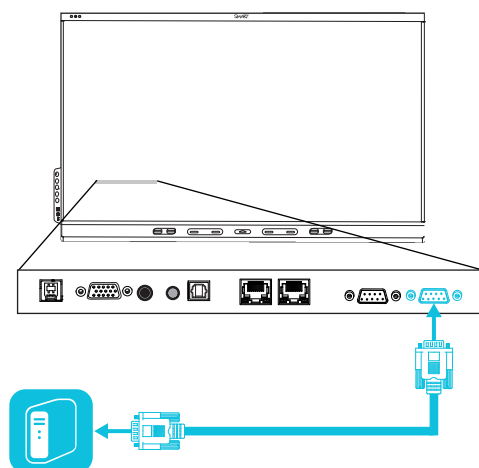

! **Important**

Use only a standard RS-232 cable. Do not use a null modem cable. Null modem cables typically have ends of the same type.

Tip

SMART also offers SMART Remote Management cloud-based device-management software, which you can use to manage SMART Board interactive displays with iQ and devices running Windows, Chrome™ OS, Android™, and iOS operating systems. For more information, see [SMART Remote Management](#).

Connecting multiple displays

You can connect up to ten displays to a room control system by connecting a RS-232 cable from the computer's serial output to the first display's RS-232 in connector and then connecting another RS-232 cable from that display's RS-232 out connector to the next display's RS-232 in connector.

Notes

- The leftmost display (when viewed from the front) is the first display in the chain, the display to the right of that display is the second display in the chain, and so on.

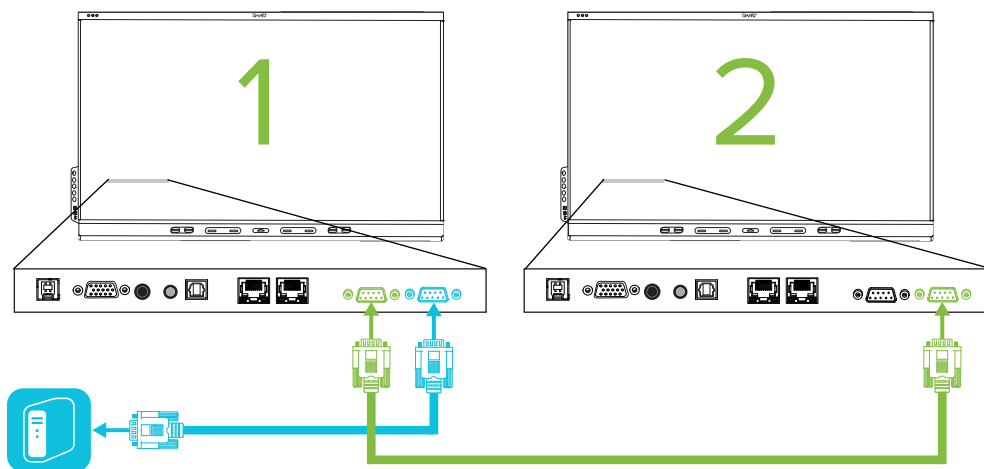

- When you connect displays in this manner, they behave as a single unit (see *Mounting multiple displays* on page 26).
- With the exception of the `get input`, `set input`, and `get fwver`, all remote management commands apply to all connected displays.

Configuring the computer's serial interface settings

Configure the computer's serial interface before sending commands to the display.

To configure the computer's serial interface

1. Turn on the display.
2. Turn on the computer, and then start the serial communications program or terminal emulation program.
3. Activate local echo.
4. Configure the serial interface settings using the following values, and then press ENTER.

Baud rate	19200
Data length	8
Parity bit	None
Stop bit	1

A command prompt (>) appears on the following line, and the display can now accept commands from the computer.

Note

If no message appears or an error message appears, the serial interface isn't configured correctly. Repeat steps 3 and 4.

Commands and responses

To access display information or to adjust display settings using the room control system, type commands after the command prompt (>) and wait for the response from the display.

Correct

```
>get volume  
volume=55  
>
```

In the example below, the user used =-50 instead of -50.

Incorrect

```
>set volume=-50
```

```
invalid cmd: setvolume=-50  
>
```

Notes

- Use ASCII formatted commands.
- Commands aren't case-sensitive and extra spacing is ignored.
- In many terminal applications on a computer, you can use the BACKSPACE key when typing commands.
- Review each entry carefully before sending a command to the display.
- Don't send another command until you receive the response and the next command prompt (>). If no command prompt is present, send a carriage return character (<CR>) to the display. If the display is ready to receive commands, it will show a command prompt after receiving the carriage return.

To retrieve a setting's current value

Use a `get` command.

This example shows how to get the volume:

```
>get volume  
volume=55  
>
```

To assign a value to a setting

Use a `set` command.

This example sets the volume to 65:

```
>set volume=65  
volume=65  
>
```

To increase or decrease the value of a setting

Use the `set` command to increase or decrease the value by a designated number.

This example increases the volume by 5:

```
>set volume+5  
volume=70  
>
```

This example decreases the volume by 15:

```
>set volume-15  
volume=55  
>
```

To identify or assign a value for a specific display

Start the command with `[Display],@`, where `[Display]` is the display you want to apply the command to.

This example sets the input for the first display in the chain to HDMI 2:

```
>A,@ set input=hdmi2  
@,A input=hdmi2  
>
```

Notes



- The first display in the chain is labeled A, the next display is labeled B, and so on.
- You can identify a specific display for only the `get input`, `set input` and `get fwversion` commands.

Power state commands

Get command	Set command	Response
get powerstate	<p>set powerstate[Value] Where [Value] is one of the following:</p> <ul style="list-style-type: none"> • =on • =ready • =standby • =powersave <p>Notes</p> <ul style="list-style-type: none"> • If the display is in UPDATEON or UPDATEREADY state, it might not change power states after receiving the command. • When switching between power states on displays running iQ 3.11 or earlier, wait at least 30 seconds before sending another command. 	<p>powerstate=[Value] Where [Value] is one of the following:</p> <ul style="list-style-type: none"> • on • ready • standby • powersave • updateon • updateready

The display has six power states:

Power state	Description
ON	The display is in normal operating mode.
READY	<p>The screen is off, but the display is ready to turn on when one of the following occurs:</p> <ul style="list-style-type: none"> • A user presses the Power button  on the convenience panel or the remote control. • A user picks up a pen or the eraser. • You send the set powerstate=on command. • The proximity sensors detect people in the room. • The display receives a video signal.

Power state	Description
STANDBY	<p>The screen is off, and the display is in a low power state. The display enters READY or ON state when one of the following occurs:</p> <ul style="list-style-type: none"> • The proximity sensors detect people in the room. • A user presses the Power button  on the convenience panel or the remote control. • You send the <code>set powerstate=ready</code> or <code>set powerstate=on</code> command. <p>This power state is the default energy saving mode for displays set to a non-EU location.</p> <p>Note The EU uses “networked standby” to describe this power state.</p>
POWERSAVE	<p>The screen is off, and the display is a very low power state. The display enters READY or ON state when one of the following occurs:</p> <ul style="list-style-type: none"> • A user presses the Power button  on the convenience panel or the remote control. • You send the <code>set powerstate=ready</code> or <code>set powerstate=on</code> command. <p>This power state is the default energy saving mode for displays set to an EU location.</p> <p>Note The EU uses “standby” to describe this power state.</p>
UPDATEON	<p>The display is updating firmware. Do not turn off the display.</p>
UPDATEREADY	<p>The display is updating firmware while the screen is off. Do not turn off the display.</p>

With the exception of `get powerstate` and `set powerstate`, commands are available only when the display is in READY or ON power state.

Input commands

Get command	Set command	Response
If one display is connected		
get input	set input[Value] Where [Value] is one of the following: <ul style="list-style-type: none"> • =hdmi1 • =hdmi2 • =hdmi3 • =vga1 • =ops1 • =usbc1 • =android <div style="border-left: 2px solid #0070C0; padding-left: 10px; margin-top: 10px;"> <p>Note</p> <p>The usbc1 set command applies only to displays equipped with USB Type-C connectors.</p> </div>	input=[Value] Where [Value] is one of the following: <ul style="list-style-type: none"> • hdmi1 • hdmi2 • hdmi3 • vga1 • ops1 • usbc1 • android • none
If multiple displays are connected		
[Display],@ get input Where [Display] is the display's label (A, B, and so on).	[Display],@ set input[Value] Where <ul style="list-style-type: none"> • [Display] is the display's label (A, B, and so on). • [Value] is one of the following: <ul style="list-style-type: none"> ◦ =hdmi1 ◦ =hdmi2 ◦ =hdmi3 ◦ =vga1 ◦ =ops1 ◦ =android 	@,[Display] input=[Value] Where <ul style="list-style-type: none"> • [Display] is the display's label (A, B, and so on). • [Value] is one of the following: <ul style="list-style-type: none"> ◦ hdmi1 ◦ hdmi2 ◦ hdmi3 ◦ vga1 ◦ ops1 ◦ android ◦ none

Brightness commands

Get command	Set command	Response
get brightness	set brightness[Value] Where [Value] is one of the following: <ul style="list-style-type: none"> • +[Value] • -[Value] • =[5-100] 	brightness=[Value] Where [Value] is a number between 5 and 100

Freeze commands

Get command	Set command	Response
get videofreeze	set videofreeze[Value] Where [Value] is one of the following: <ul style="list-style-type: none"> • =on • =off 	videofreeze=[Value] Where [Value] is one of the following: <ul style="list-style-type: none"> • on • off

Screen shade commands

Get command	Set command	Response
get screenshade	set screenshade[Value] Where [Value] is one of the following: <ul style="list-style-type: none"> • =on • =off 	screenshade=[Value] Where [Value] is one of the following: <ul style="list-style-type: none"> • on • off

Volume commands

Get command	Set command	Response
get volume	set volume[Value] Where [Value] is one of the following: <ul style="list-style-type: none"> • +[Value] • -[Value] • =[0-100] 	volume=[Value] Where [Value] is a number between 0 and 100

Mute commands

Get command	Set command	Response
get mute	set mute[Value] Where [Value] is one of the following: <ul style="list-style-type: none"> • =on • =off 	mute=[Value] Where [Value] is one of the following: <ul style="list-style-type: none"> • on • off

Firmware version commands

Get command	Response
If one display is connected	
get fwversion	fwversion=[Value] Where [Value] is the firmware version.
If multiple displays are connected	
[Display],@ get fwversion Where [Display] is the display's label (A, B, and so on).	@,[Display] fwversion=[Value] Where <ul style="list-style-type: none"> [Display] is the display's label (A, B, and so on). [Value] is the firmware version.

Serial number commands

Get command	Response
get serialnum	serialnum=[Value] Where [Value] is the serial number.
	<p>Note</p> <p>If multiple displays are connected, the response includes the serial numbers for all displays separated by commas.</p>

Part number commands

Get command	Response
get partnum	partnum=[Value] Where [Value] is the part number, including the revision.
	<p>Note</p> <p>If multiple displays are connected, the response includes the part numbers for all displays separated by commas.</p>

Resolving issues with managing the display using RS-232

The following table presents common issues with managing the display using RS-232 and explains how to resolve them:

Symptom	Troubleshooting steps
Managing the display using RS-232 isn't working as expected.	<ul style="list-style-type: none">• Make sure all the cable connections are secure.• Restart the display and the remote management system. <i>See Turning off, turning on, and resetting the display on page 45.</i>• Configure the serial interface settings in your RS-232 terminal application. <i>See Configuring the computer's serial interface settings on page 84.</i>
You're experiencing other issues with managing the display using RS-232, or the previous steps don't resolve the issue.	See <i>Chapter 5 Troubleshooting</i> on page 51.

Certification and compliance

Federal Communication Commission interference statement

FCC

Supplier's Declaration of Conformity

47 CFR § 2.1077 Compliance Information

Unique Identifier: IDS665-3, IDS675-3, IDS686-3, IDS665-1, IDS675-1, IDS686-1

Responsible Party – U.S. Contact Information

SMART Technologies Inc.

2401 4th Ave, 3rd Floor

Seattle, WA 98121

compliance@smarttech.com

This device complies with Part 15 of the FCC Rules. Operation is subject to the following two conditions:

1. This device may not cause harmful interference, and
2. this device must accept any interference received, including interference that may cause undesired operation.

Note

This equipment has been tested and found to comply with the limits for a Class A digital device, pursuant to part 15 of the FCC Rules. These limits are designed to provide reasonable protection against harmful interference when the equipment is operated in a commercial environment. This equipment generates, uses, and can radiate radio frequency energy and, if not installed and used in accordance with the instruction manual, may cause harmful interference to radio communications. Operation of this equipment in a residential area is likely to cause harmful interference in which case the user will be required to correct the interference at his own expense.

⚠ Caution

Any changes or modifications not expressly approved by the party responsible for compliance could void the user's authority to operate this equipment.

Restriction

Operations in the 5.15–5.25GHz band are restricted to indoor usage only.

IEEE 802.11b or 802.11g operation of this product in the USA is firmware limited to channels 1 through 13.

Radiation exposure statement

This equipment complies with FCC radiation exposure limits set forth for an uncontrolled environment. This equipment should be installed and operated with minimum distance of 20 cm between the antenna of this device and all nearby persons. This transmitter must not be co-located or operated in conjunction with any other antenna or transmitter.

Innovation, Science and Economic Development Canada statement

This device complies with RSS-210 of the Innovation, Science and Economic Development Canada Rules. Operation is subject to the following two conditions:

1. This device may not cause harmful interference, and
2. this device must accept any interference received, including interference that may cause undesired operation.

⚠ Caution

(i) the device for operation in the band 5150–5250 MHz is only for indoor use to reduce the potential for harmful interference to co-channel mobile satellite systems;

(ii) the maximum antenna gain permitted for devices in the bands 5250–5350 MHz and 5470–5725 MHz shall comply with the e.i.r.p. limit; and

(iii) the maximum antenna gain permitted for devices in the band 5725–5825 MHz shall comply with the e.i.r.p. limits specified for point-to-point and non point-to-point operation as appropriate.

(iv) Users should also be advised that high-power radars are allocated as primary users (i.e., priority users) of the bands 5250–5350 MHz and 5650–5850 MHz and that these radars could cause interference and/or damage to LE-LAN devices.

Radiation exposure statement

This equipment complies with ISED radiation exposure limits set forth for an uncontrolled environment. This equipment should be installed and operated with minimum distance of 20 cm between the antenna of this device and all nearby persons. This transmitter must not be co-located or operated in conjunction with any other antenna or transmitter.

Certification and compliance

Innovation, Science et Développement économique Déclaration du Canada

Cet appareil est conforme à la norme ISED CNR-210 pour les appareils radio agréés. Son fonctionnement est soumis aux deux conditions suivantes:

1. le dispositif ne doit pas produire de brouillage préjudiciable, et
2. ce dispositif doit accepter tout brouillage reçu, y compris un brouillage susceptible de provoquer un fonctionnement indésirable.

Avertissement

(i) les dispositifs fonctionnant dans la bande 5 150-5 250 MHz sont réservés uniquement pour une utilisation à l'intérieur afin de réduire les risques de brouillage préjudiciable aux systèmes de satellites mobiles utilisant les mêmes canaux;

(ii) le gain maximal d'antenne permis pour les dispositifs utilisant les bandes 5 250-5 350 MHz et 5 470-5 725 MHz doit se conformer à la limite de p.i.r.e.;

(iii) le gain maximal d'antenne permis (pour les dispositifs utilisant la bande 5 725-5 825 MHz) doit se conformer à la limite de p.i.r.e. spécifiée pour l'exploitation point à point et non point à point, selon le cas.

(iv) De plus, les utilisateurs devraient aussi être avisés que les utilisateurs de radars de haute puissance sont désignés utilisateurs principaux (c.-à-d., qu'ils ont la priorité) pour les bandes 5 250-5 350 MHz et 5 650-5 850 MHz et que ces radars pourraient causer du brouillage et/ou des dommages aux dispositifs LAN-EL.

Déclaration d'exposition aux radiations

Cet équipement est conforme aux limites d'exposition aux rayonnements ISED établies pour un environnement non contrôlé. Cet équipement doit être installé et utilisé avec un minimum de 20 cm de distance entre la source de rayonnement et votre corps. Cet émetteur ne doit pas être co-implantés ou exploités conjointement avec une autre antenne ou émetteur.

EU Declaration of Conformity

Hereby, SMART Technologies ULC declares that the radio equipment type Interactive Display **IDS665-3, IDS675-3, IDS686-3, IDS665-1, IDS675-1, IDS686-1** and the **OPS AM50, PCM8**, are in compliance with Directive 2014/53/EU.

The full text of the EU declaration of conformity is available at the following Internet address: smarttech.com/compliance

Warning

Operation of this equipment in a residential environment could cause radio interference.

The frequency band and the maximum transmitted power in EU are listed below:

Regulatory models: IDS665-3, IDS675-3, IDS686-3, IDS665-1, IDS675-1, IDS686-1

Transmitting Band (MHz)	Maximum Transmit Power dBuV/m @ 10m
13.56	-9

Transmitting Band (MHz)	Maximum Transmit Power dBm
2402-2483.5	20
5150-5350	22
5470-5725	22

Restrictions in:

AT/BE/BG/CZ/DK/EE/FR/DE/IS/IE/IT/EL/ES/CY/LV/LI/LT/LU/HU/MTNL/NO/PL/PT/RO/SI/SK/TR/FI/SE/CH/UK/HR – 5150MHz-5350MHz is for indoor use only.

Regulatory models: OPS AM50, PCM8

Transmitting Band (MHz)	Maximum Transmit Power dBm
2402-2483.5	20
5150-5350	22
5470-5725	22
5745-5875	13

Restrictions in:

AT/BE/BG/CZ/DK/EE/FR/DE/IS/IE/IT/EL/ES/CY/LV/LI/LT/LU/HU/MTNL/NO/PL/PT/RO/SI/SK/TR/FI/SE/CH/UK/HR – 5150MHz-5350MHz is for indoor use only.

For optimal performance any support equipment connected to this device must be CE compliant.

Japan VCCI Class A statement – applicable only to models certified for sale in Japan

この装置は、クラスA情報技術装置です。この装置を家庭環境で使用すると電波妨害を引き起こすことがあります。この場合には使用者が適切な対策を講ずるよう要求されることがあります。VCCI-A 日本国内は100V交流動作のみに制限されています。

This is a Class A product based on the standard of the Voluntary Control Council for Interference (VCCI). If this equipment is used in a domestic environment, radio interference may occur, in which case the user may be required to take corrective actions.

Operation in Japan is restricted to 100V AC operation only.

Certification and compliance

United Arab Emirates – TRA registration details

Panel 65"

Regulatory models IDS665-3

TRA
REGISTERED No: ER02349/21
DEALER No: DA0076339/11

Regulatory models IDS665-1

TRA
REGISTERED No: ER78098/20
DEALER No: DA0076339/11

Panel 75"

Regulatory models IDS675-3

TRA
REGISTERED No: ER02350/21
DEALER No: DA0076339/11

Regulatory models IDS675-1

TRA
REGISTERED No: ER78099/20
DEALER No: DA0076339/11

Panel 86"

Regulatory models IDS686-3

TRA
REGISTERED No: ER02351/21
DEALER No: DA0076339/11

Regulatory models IDS686-1

TRA
REGISTERED No: ER81697/20
DEALER No: DA0076339/11

Electrical and electronic equipment and batteries contain substances that can be harmful to the environment and to human health. The crossed-out wheeled bin symbol indicates that products should be disposed of in the appropriate recycling stream and not as regular waste.

Batteries

The SMART Board 6000S, SMART Board 6000S Pro, SMART Board 6000S (C) and SMART 6000S (C) Pro displays contain a CR2032 coin cell battery. The SMART Board 6000S (V3) and SMART 6000S (V3) Pro displays contain a CR1220 coin cell battery. The remote contains two AAA batteries. Recycle or dispose of batteries properly.

Perchlorate material

The product coin cell battery contains perchlorate material. Special handling may apply. See dtsc.ca.gov/hazardouswaste/perchlorate.

More information

See smarttech.com/compliance for more information.

Hardware environmental compliance

SMART Technologies supports global efforts to ensure that electronic equipment is manufactured, sold, and disposed of in a safe and environmentally friendly manner.

**Waste
Electrical
and
Electronic
Equipment
(WEEE)**



SMART Technologies

smarttech.com/support

smarttech.com/contactsupport

smarttech.com/kb/171414